

DLP Cinema® Projector

**NEC**

# User's Manual

---

DLP Cinema® Projector

**NC1700L**

Chiller Unit

**NP-17CU01**

Sharp NEC Display Solutions, Ltd.

Model No.  
NP-NC1700L

# Important Information

**Precautions:** Please read this manual carefully before using your **NC1700L** and keep the manual handy for future reference.

The NC1700L (projector unit) is called the “projector”, the NP-17CU01 (chiller unit) is called the “chiller unit”, and the NP-90MS02 (integrated media server) is called the “media block” or “IMB” in this manual.

- DLP, DLP Cinema and their respective logos are trademarks or registered trademarks of Texas Instruments.
- Microsoft, Windows and Internet Explorer are either registered trademarks or trademarks of Microsoft Corporation in the United States and/or other countries.
- Java is a registered trademark of Oracle and/or its affiliates.
- Other product names and manufacturer names described in this manual are the registered trademarks or trademarks of their respective companies.
- The display screens and illustrations shown in this manual may differ slightly from the actual ones.
- GPL/LGPL Software Licenses  
The product includes software licensed under GNU General Public License (GPL), GNU Lesser General Public License (LGPL), and others.  
For more information on each software, see “readme.pdf” inside the “about GPL&LGPL” folder on the supplied CD-ROM.

 **WARNING**

TO PREVENT FIRE OR SHOCK HAZARDS, DO NOT EXPOSE THIS UNIT TO RAIN OR MOISTURE.

 **CAUTION**

TO REDUCE THE RISK OF ELECTRIC SHOCK, DO NOT OPEN COVER. NO USER-SERVICEABLE PARTS INSIDE. REFER SERVICING TO QUALIFIED SERVICE PERSONNEL.

 This symbol warns the user that uninsulated voltage within the unit may have sufficient magnitude to cause electric shock. Therefore, it is dangerous to make any kind of contact with any part inside of this unit.

 This symbol alerts the user that important literature concerning the operation and maintenance of this unit has been included. Therefore, it should be read carefully in order to avoid any problems.

## Laser Safety Caution

This product is classified as Class 1 of IEC60825-1 Third edition 2014. This product is classified as RG3 of IEC62471-5 First edition 2015. Obey the laws and regulations of your country in relation to the installation and management of the device.

 **CAUTION**

Use of controls or adjustments of procedures other than those specified herein may lead to hazardous laser radiation exposure.

This products is classified as Class 4 of IEC60825-1:2007. Obey the laws and regulations of your country in relation to the installation and management of the device.



**LASER APERTURE**

**OUVERTURE DU LASER**

For North America

**LASER RADIATION**

AVOID EYE OR SKIN EXPOSURE TO DIRECT OR SCATTERED RADIATION

---

RED Max. 890 mW LD, CW 636-642 nm  
BLUE Max. 800 mW LD, CW 450-460 nm

---

**CLASS 4 LASER PRODUCT**

**RAYONNEMENT LASER**

ÉVITEZ D'EXPOSER LES YEUX OU LA PEAU AUX RAYONNEMENTS DIRECTS OU DIFFUSÉS

---

ROUGE Max. 890 mW LD, CW 636-642 nm  
BLEU Max. 800 mW LD, CW 450-460 nm

---

**PRODUIT LASER DE CLASSE 4**

**IEC 60825-1:2007**



**LASER**  
1



レーザー  
クラス 1

JIS C 6802:2014



第 1 类  
激光

IEC/EN 60825-1:2014



3282145600

 **CAUTION – CLASS 4 LASER PRODUCT**

LASER LIGHT – AVOID EYE OR SKIN EXPOSURE TO DIRECT OR SCATTERED RADIATION

- Do not look into the lens while the projector is on. Serious damage to your eyes could result.

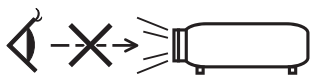



- Keep any items such as magnifying glass out of the light path of the projector. The light being projected from the lens is extensive, therefore any kind of abnormal objects that can redirect light coming out of the lens, can cause unpredictable outcome such as fire or injury to the eyes.
- When turning on the projector, ensure that nobody is facing towards the lens in the path of the light emitted from the laser.
- This product can only be operated in theaters by specified personnel. Customers should not operate this product.

**DOC Compliance Notice (for Canada only)**

This Class A digital apparatus meets all requirements of the Canadian ICES-003 Standards.

 <b>WARNING</b>
<p>This is a Class A product. In a domestic environment this product may cause radio interference in which case the user may be required to take adequate measures.</p>

 <b>CAUTION</b>
<ul style="list-style-type: none"> <li>• In order to reduce any interference with radio and television reception use a signal cable with ferrite core attached. Use of signal cables without a ferrite core attached may cause interference with radio and television reception.</li> <li>• This equipment has been tested and found to comply with the limits for a Class A digital device, pursuant to Part 15 of the FCC Rules. These limits are designed to provide reasonable protection against harmful interference when the equipment is operated in a commercial environment. This equipment generates, uses, and can radiate radio frequency energy and, if not installed and used in accordance with the installation manual, may cause harmful interference to radio communications. Operation of this equipment in a residential area is likely to cause harmful interference in which case the user will be required to correct the interference at his own expense.</li> </ul>

 <b>WARNING</b>
<p>THE END USER IS NOT ALLOWED TO OPEN OR MODIFY THE PRODUCT.          NO USER SERVICEABLE PARTS.          MAINTAIN AND SERVICE OF THE PRODUCT IS ONLY TO BE HANDLED BY NEC AUTHORIZED TECHNICIANS.</p>

**Important Safeguards**

These safety instructions are to ensure the long life of your projector and to prevent fire and shock. Please read them carefully and heed all warnings.

**Installation**

1. Do not point the projection beam toward other people or reflective objects.
2. Consult your dealer for information about transporting and installing the projector. Do not attempt to transport and install the projector yourself. The projector must be installed by qualified technicians in order to ensure proper operation and reduce the risk of bodily injury.
3. Place the projector on a flat, level surface in a dry area away from dust and moisture. Tilting the front of the projector up or down from level could reduce laser life. Do not put the projector on its side when the laser is on. Doing so may cause damage to the projector.
4. Do not place the projector in direct sunlight, near heaters or heat radiating appliances.
5. Exposure to direct sunlight, smoke or steam could harm internal components.
6. Handle your projector carefully. Dropping or jarring your projector could damage internal components.
7. When moving the projector, be sure to remove the lens and chiller unit from the projector before moving it.
8. To carry the projector, a minimum of four persons are required.
9. Do not hold the lens part with your hand. Otherwise the projector may tumble or drop, causing personal injury.
10. Do not place heavy objects on top of the projector.
11. Turn off the projector, and disconnect the power cable before moving the projector.
12. The cooling fan settings need to be configured when using the projector in a location at an altitude of approximately 5500 feet/1600 meters or higher. Consult your dealer in advance.
13. Turn off the projector when removing and installing lenses. Failure to do so can cause loss of vision.
14. Do not install and store the projector in the below circumstances. Failure to do so may cause of malfunction.
  - In powerful magnetic fields
  - In corrosive gas environment
  - Outdoors
15. When moving the projector, check the following:
  - That the projector and chiller unit are turned off, the power plug is disconnected from the outlet
  - That the connector cable and hose that connects the device to the projector is unplugged

### **WARNING**

1. Do not cover the lens with the supplied lens cap or equivalent while the projector is on. Doing so can lead to distorting or melting of the cap and burning your hands due to the heat emitted from the light output.
2. Do not place any objects, which are easily affected by heat, in front of the projector lens. Doing so could lead to the object melting from the heat that is emitted from the light output.



When using the projector tilted in the forward or backward direction, use it in the range of (+10° to -15°) from horizontal. If you tilt it outside of this range or tilt it to the left or right, it may become damaged.

If the projector is tilted outside of this range when used tilted in the forward or backward direction, "TiltDegreeOver" is displayed on the LCD screen. If this message appears, change the installation of the projector so that the angle is within the given range from horizontal.

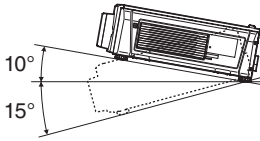

When installed on a floor or a desktop

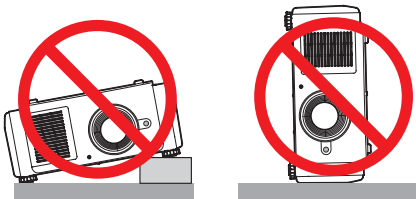

### **Power Supply**

1. The projector is so designed that it operates with the power supply voltage described below.
  - AC200–240V 10.7A (MAX) 50/60Hz Single-phaseEnsure that your power supply fits this requirement before attempting to use your projector.
2. The power cable is not included with the projector. Ask your dealer for the power cable to select and purchase. Use a power cable that meets the standards and power supply voltage of the country where you are using the projector. Refer to "2-2. Connecting the Power Cable" (page 30) for details on connecting the power cable. Ask your dealer regarding the installation or removal of AC power cable for chiller unit.
3. Handle the power cable carefully. A damaged or frayed power cable can cause electric shock or fire.
  - Do not bend or tug the power cable excessively.
  - Do not place the power cable under the projector, or any heavy object.
  - Do not cover the power cable with other soft materials such as rugs.
  - Do not heat the power cable.
  - Do not change the arrangement of the installed power cable.
4. If the projector will not be used for an extended period of time, turn off the projector and chiller unit, and disconnect the power plug from the outlet.
5. Placing the power cable and the signal cable closely to each other can cause beat noise. If this happens, keep the two separated so that beat noise is not generated. Beat noise is corruption of the picture often seen as a rolling band moving through the image.
6. Do not touch the projector during a thunder storm. Doing so can cause electrical shock or fire.

**Fire and Shock Precautions**

1. Ensure that there is sufficient ventilation and that vents are unobstructed to prevent potentially dangerous concentrations of ozone and the build-up of heat inside your projector. Allow at least 12 inches (30cm) of space between your projector and a wall. In particular, clear a space of 27.6 inches (70 cm) or more in front of the air outlet on the rear surface. Allow at least 19.8 inches (50 cm) of space between your chiller unit and a wall.
2. Prevent foreign objects such as paper clips and bits of paper from falling into your projector. Do not attempt to retrieve any objects that might fall into your projector. Do not insert any metal objects such as a wire or screwdriver into your projector. If something should fall into your projector, turn off the projector and chiller unit, disconnect the power plug from the outlet and have the object removed by a qualified service person.
3. Turn off the projector, unplug the power cable and have the projector serviced by a qualified service personnel under the following conditions:
  - When the power cable or plug is damaged or frayed.
  - If liquid has been spilled into the projector, or if it has been exposed to rain or water.
  - If the projector does not operate normally when you follow the instructions described in this user’s manual.
  - If the projector has been dropped or the cabinet has been damaged.
  - If the projector exhibits a distinct change in performance, indicating a need for service.
4. Keep any items such as magnifying glass out of the light path of the projector. The light being projected from the lens is extensive, therefore any kind of abnormal objects that can redirect light coming out of the lens, can cause unpredictable outcome such as fire or injury to the eyes.
5. When using a LAN cable:  
For safety, do not connect to the connector for peripheral device wiring that might have excessive Voltage.
6. Do not try to touch the air outlets on the projector during normal projector operation as it is hot.

**Cleaning**

1. Turn off the projector and unplug the power cable before cleaning the cabinet or replacing the laser.
2. During cleaning, turn off the projector and chiller unit, and disconnect the power plug from the outlet.
3. Clean the cabinet periodically with a cloth. If heavily soiled, use a mild detergent. Never use strong detergents or solvents such as alcohol or thinner.
4. Use a blower or lens paper to clean the lens, and be careful not to scratch or mar the lens.
5. Do not touch the projector or the power plug with wet hand. Doing so can cause electrical shock or fire.



**CAUTION**

1. Do not unplug the power cable from the wall outlet or projector when the projector is powered on. Doing so can damage the projector.
  - While projecting images
  - While cooling after the projector has been turned off.  
(The POWER button LED blinks in green while the fan is rotating, and “cooling...” is displayed on the LCD screen.)
2. Do not turn of the AC power for 90 seconds after the laser is turned on and while the POWER indicator is blinking green. Doing so could cause premature laser failure.
3. Use of a wall outlet with a 20 A or more circuit breaker is recommended.

**Caution on Carrying the Projector/Handling the Optional Lens**

When shipping the projector with the lens, remove the lens before shipping the projector. Always attach the dust cap to the lens whenever it is not mounted on the projector. The lens and the lens shift mechanism may encounter damage caused by improper handling during transportation.

**WARNING TO CALIFORNIA RESIDENTS:**

Handling the cables supplied with this product will expose you to lead, a chemical known to the State of California to cause birth defects or other reproductive harm. WASH HANDS AFTER HANDLING

## Important Information

---

### Light Module

1. A light module containing multiple laser diodes is included in the product as the light source.
2. These laser diodes are sealed in the light module. No maintenance or service is required for the performance of the light module.
3. End user is not allowed to replace the light module.
4. Contact qualified distributor for light module replacement and further information.

### Disposing of your used product



EU-wide legislation as implemented in each Member State requires that used electrical and electronic products carrying the mark (left) must be disposed of separately from normal household waste.

This includes projectors and their electrical accessories. When you dispose of such products, please follow the guidance of your local authority and/or ask the shop where you purchased the product.

After collecting the used products, they are reused and recycled in a proper way. This effort will help us reduce the wastes as well as the negative impact to the human health and the environment at the minimum level.

The mark on the electrical and electronic products only applies to the current European Union Member States.



**For EU:** The crossed-out wheeled bin implies that used batteries should not be put to the general household waste! There is a separate collection system for used batteries, to allow proper treatment and recycling in accordance with legislation.

**According to the EU directive 2006/66/EC, the battery can't be disposed improperly. The battery shall be separated to collect by local service.**

### For questions relating to unclear points or repairs

Contact your dealer or the following support branch for questions relating to unclear points, malfunctions and repairs of the product.

### In Europe

Company Name: Sharp NEC Display Solutions Europe GmbH  
Address: Landshuter Allee 12-14, D-80637 Munich, Germany  
Telephone: +49 89 99699 0  
Fax Line: +49 89 99699 500  
Email Address: [infomail@nec-displays.com](mailto:infomail@nec-displays.com)  
WEB Address: <https://www.sharpnecdisplays.eu>

### In North America

Company Name: Sharp NEC Display Solutions of America, Inc.  
Address: 3250 Lacey Rd, Ste 500 Downers Grove, IL 60515 U.S.A.  
Telephone: +1 866-632-6431  
Fax Line: +1 800 356 2415  
Email Address: [cinema.support@sharpnec-displays.com](mailto:cinema.support@sharpnec-displays.com)  
WEB Address: <https://www.sharpnecdisplays.us>

### In China

Company Name: NEC (China) Co., Ltd.  
Address: 6F, Landmark diplomatic office building D2, No. 19 East Road, Chaoyang District, Beijing 100600, R.P.C.  
Telephone: 010-59342706  
Email Address: [nec-support@nec.cn](mailto:nec-support@nec.cn)

### In Hong Kong and Taiwan

Company Name: Strong Westrex, Inc.  
Address: Room 4108 China Resources Building, No. 26 Harbour Road, Wanchai, Hong Kong  
Telephone: +852 2827 8289  
Fax Line: +852 2827 5993  
Email Address: [Felix.chen@btn-inc.com](mailto:Felix.chen@btn-inc.com)

### In South Korea

Company Name: Hyosung ITX Co., Ltd.  
Address: 1F, Ire Building, 2, Yangpyeong-dong 4-ga, Yeongdeungpo-gu, Seoul, Korea 150-967  
Telephone: +82-2-2102-8591  
Fax Line: +82-2-2102-8600  
Email Address: [moneybear@hyosung.com](mailto:moneybear@hyosung.com)  
WEB Address: <http://www.hyosungitx.com>

### In Australia and New Zealand

Company Name: NEC Australia Pty Ltd  
Address: 26 Rodborough Road Frenchs Forest NSW 2086  
Telephone: 131 632 (from anywhere in Australia)  
Email Address: [displays@nec.com.au](mailto:displays@nec.com.au)  
WEB Address: <http://www.nec.com.au>

### In Thailand, Singapore, Malaysia, Indonesia and Philippines

Company Name: Goldenduck International Co., Ltd.  
Address: 65 Soi Phutthamothon Sai 1, 21 Bangramad, Talingchan, Bangkok, Thailand 10170  
Telephone: +66-2887-8807  
Fax Line: +66-2887-8808  
Email Address: [contact@goldenduckgroup.com](mailto:contact@goldenduckgroup.com)

## Laser Aperture Modules

- The laser module is equipped in this product.  
Use of controls or adjustments of procedures other than those specified herein may lead to hazardous laser radiation exposure.
- This product is classified as Class 4 of IEC60825-1 Second edition 2007.  
This product is classified as Class 1 of IEC60825-1 Third edition 2014.  
This product is classified as RG3 of IEC62471-5 First edition 2015.  
Obey the laws and regulations of your country in relation to the installation and management of the device.  
Internal laser output of the laser module  
Blue laser diodes: Wave length 450-460 nm, Output power 450 W  
Red laser diodes: Wave length 636-642 nm, Output power 100 W



### **WARNING**

Always wear laser protection glasses (that meet the following conditions) while working to protect your eyes.

<Requirements for laser protection glasses>

- Optical density: Blue (450 - 460 nm) OD4 or higher, Red (636 - 642 nm) OD4 or higher
- Transmissivity of visible light: 4.5% or higher

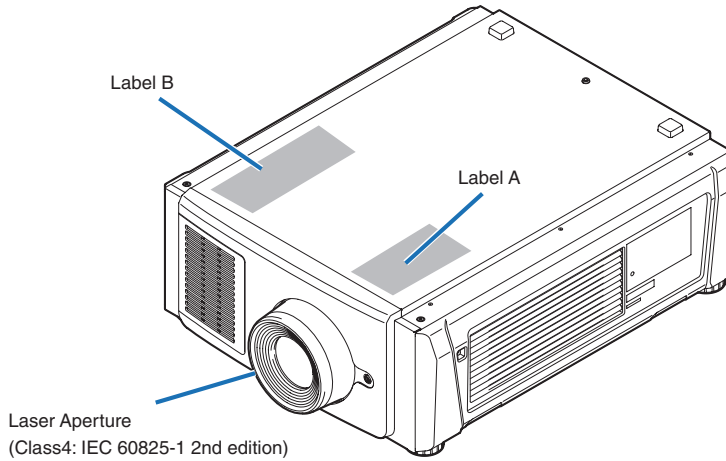

Label A: Hazard Warning Symbol, Explanatory Label and Aperture Label

Label B: Risk Group / Lamp Safety Label

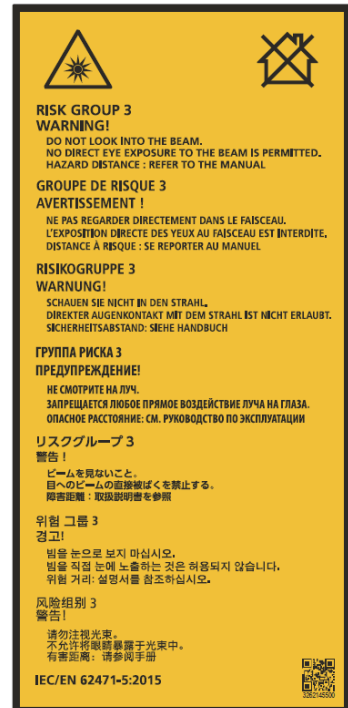
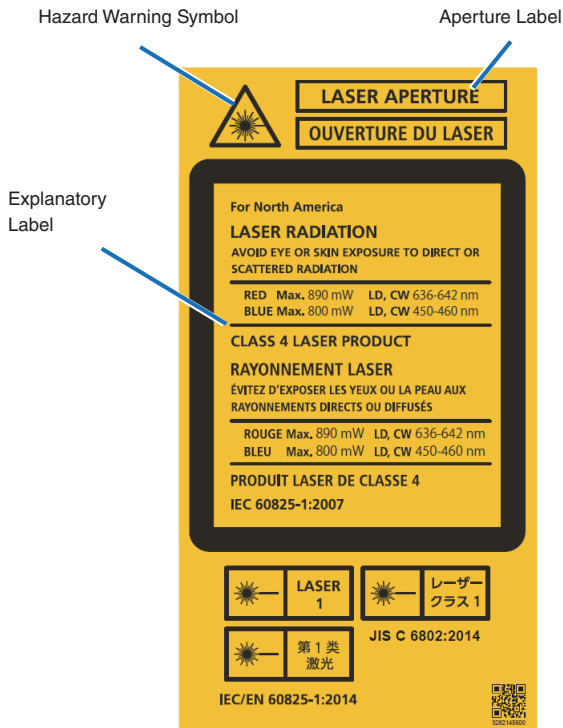





# Important Information

Chiller unit (NP-17CU01) Label

F-Gas Label

**F-Gas Label**

Contains fluorinated greenhouse gases. Contient des gaz à effet de serre fluorés. Enthält fluorierte Treibhausgase. Contiene gases fluorados de efecto invernadero. Contém gases fluorados com efeito estufa. Содержит фторированные парниковые газы. 불소계 온실 가스를 포함합니다. 含有温室氟化气体。	Hermetically Sealed Fermés hermétiquement Hermetisch versiegelt Sellado herméticamente Hermeticamente fechado Герметично запечатано 밀봉 气密密封												
<table border="0" style="width: 100%;"> <tr> <td>REFRIGERANT TYPE</td> <td>R134a</td> </tr> <tr> <td>CHARGE IN kg :</td> <td>1.09 kg</td> </tr> <tr> <td>CO2 eq</td> <td>1.56 tonnes CO2 eq</td> </tr> <tr> <td>GWP</td> <td>1430</td> </tr> <tr> <td>H/Pressure</td> <td>17.3bar</td> </tr> <tr> <td>L/Pressure</td> <td>4.2bar</td> </tr> </table>		REFRIGERANT TYPE	R134a	CHARGE IN kg :	1.09 kg	CO2 eq	1.56 tonnes CO2 eq	GWP	1430	H/Pressure	17.3bar	L/Pressure	4.2bar
REFRIGERANT TYPE	R134a												
CHARGE IN kg :	1.09 kg												
CO2 eq	1.56 tonnes CO2 eq												
GWP	1430												
H/Pressure	17.3bar												
L/Pressure	4.2bar												
<p><b>フロン排出抑制法 第一種特定製品</b></p> <p>この製品には冷媒として、フロン類(HFC)が使われています。                  (1) フロン類をみだりに大気中に放出することは禁じられています。                  (2) この製品を廃棄する場合には、フロン類の回収が必要です。                  (3) 本製品に使用しているフロン類の冷媒番号・量は以下になります。                  (4) 算定漏えい量の報告に使用するフロン類のGWP値は以下になります。</p> <table border="0" style="width: 100%;"> <tr> <td>冷媒番号</td> <td>R134a</td> </tr> <tr> <td>冷媒量</td> <td>1.09 kg</td> </tr> <tr> <td>GWP値</td> <td>1430</td> </tr> </table>		冷媒番号	R134a	冷媒量	1.09 kg	GWP値	1430						
冷媒番号	R134a												
冷媒量	1.09 kg												
GWP値	1430												
 <p>3264631400 XX XX</p>													

NP-17CU01 ID Label

<b>NEC</b>	<b>MODEL No. NP-17CU01</b> 200-240V ~ 50Hz 9.2A 220-240V ~ 60Hz 10.3A	3264634601 XX XX	
<p><b>Chiller</b></p> <p style="font-size: small;">This device complies with part 15 of the FCC rules. Operation is subject to the following two conditions:                  (1) this device may not cause harmful interference, and (2) this device must accept any interference received, including interference that may cause undesired operation.</p> <p style="font-size: x-small;">CAN ICES-3 (A)/NMB-3(A)</p>			
 TÜV Rheinland	<p><b>CAUTION</b></p> <p><b>ATTENTION</b></p> <p><b>HINWEIS</b></p> <p><b>ВНИМАНИЕ</b></p> <p><b>주의</b></p> <p><b>WARNING</b></p> <p><b>AVERTISSEMENT</b></p>	<p><b>TO PREVENT ELECTRIC SHOCK, DO NOT OPEN TOP COVER. NO USER-SERVICEABLE PARTS INSIDE. INDOOR USE ONLY.</b></p> <p><b>-AFIN DE PREVENIR UN CHOC ELECTRIQUE NE PAS ENLEVER LE COUVERCLE S'ADRESSER A UN REPARATEUR COMPETENT. UTILISATION A L'INTERIEUR SEULEMENT.</b></p> <p><b>Zur Vermeidung eines elektrischen Schläges, öffnen Sie das Gehäuse nicht selbst. In diesem Gerät sind keine Teile enthalten, die vom Nutzer gewartet werden können. NUR INNEN BENUTZEN</b></p> <p><b>-ВО ИЗБЕЖАНИЕ УДАРА ЭЛЕКТРИЧЕСКИМ ТОКОМ НЕ ОТКРЫВАЙТЕ ВЕРХНИЮ КРЫШКУ. ВНУТРИ НЕТ ДЕТАЛЕЙ, ОБСЛУЖИВАЕМЫХ ПОЛЬЗОВАТЕЛЕМ. Только для внутреннего использования</b></p> <p><b>전기충격 방지를 위해 캐시 덮개 열지 마십시오. 내부에는 사용자를 위한 서비스가능 부품이 들어있지 않습니다. 실내 사용 만</b></p> <p><b>-TO REDUCE THE RISK OF FIRE OR ELECTRIC SHOCK, DO NOT EXPOSE THIS APPLIANCE TO RAIN OR MOISTURE.</b></p> <p><b>-POUR EVITER UN FEU OU UN RISQUE D'ELECTROCUTION NE PAS EXPOSER CET ENSEMBLE A LA PLUIE OU A L'HUMIDITE.</b></p>	<p>제품명: Chiller                  모델명: NP-17CU01                  제조국가: MSIP-REM-DVP-NP-17CU01</p> <p><b>Kaukan Industries Co., Ltd / 대만</b>                  입력전력: AC200-240V ~, 50Hz, 9.2A                  AC220-240V ~, 60Hz, 10.3A</p> <p>생산일: 일련번호에 표기                  인종 서비스 센터 전화 번호:                  080-022-1155 (홍콩 ITX 주식회사)                  *본 라벨의 진화번호는 국내 규정 내에서 적절한 목적으로만 사용되어야 합니다.</p>
<p>イ、通風孔をふさがないでください。                  内部温度の上昇を招き故障の原因になります。                  口、湿度の高い場所や湿気の多い場所での使用はさけてください。                  室内専用です。</p>		<p>NEC Display Solutions, Ltd.                  A-58, Mita 1-chome, Minato-ku,                  Tokyo                  108-0073, Japan</p> <p>Contact address for EMEA                  NEC Display Solutions Europe GmbH                  Landshuter Allee 12-14 80637                  Munich, Germany</p> <p>Made in Taiwan                  THIS CABINET IS CONSTRUCTED OF                  METAL (A) and PLASTIC (P) ABS</p>	
<p><b>⚠ 警告 高圧注意</b></p> <p>サービスマン以外の方はトップカバーを開かないでください。                  内部には高電圧部分が多くあり、                  万一さわると危険です。</p>			

■ Laser light specifications

Class	Class 4 laser product
Wavelength	Blue: 450 - 460 nm, Red: 636 - 642 nm
Maximum optical output	Blue (450 - 460 nm): 800 mW, Red (636 - 642 nm): 890 mW
Beam diameter	10 mm
Divergence	2 Degree to 22 Degree, lens dependent
Pulse duration	CW (Continuous Wave)
Modulation	23 - 192 Hz, due to frame rate
MPE	Blue (450 - 460 nm), Red (636 - 642 nm): 260 J/m <sup>2</sup>
NOHD	11 m
Exposure duration	10 seconds

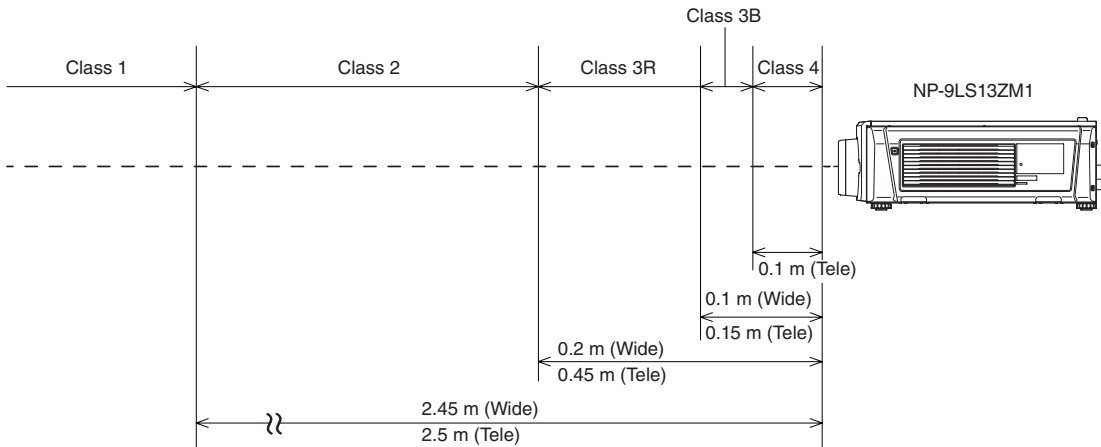
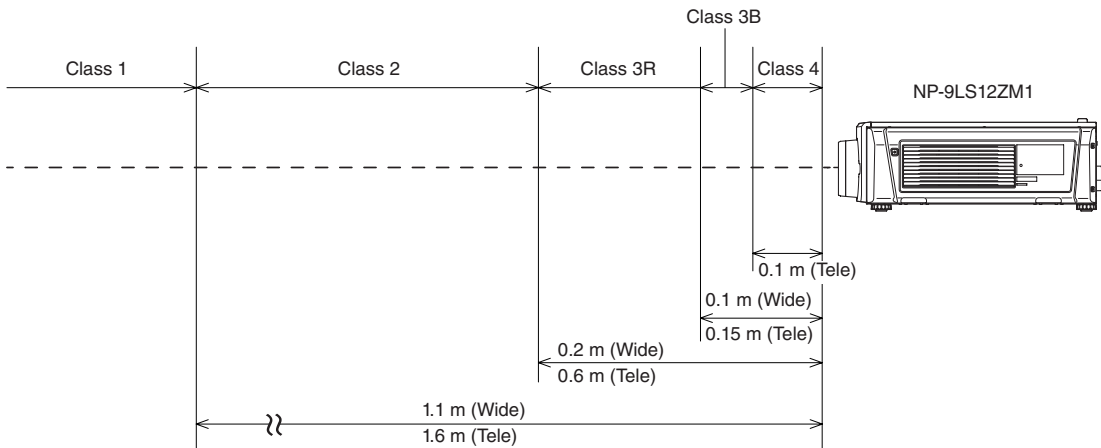

# Important Information

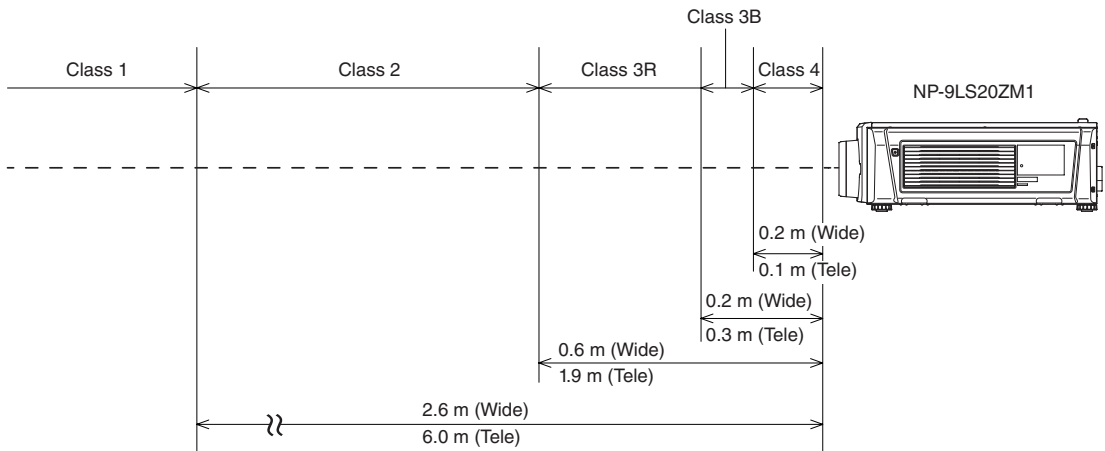
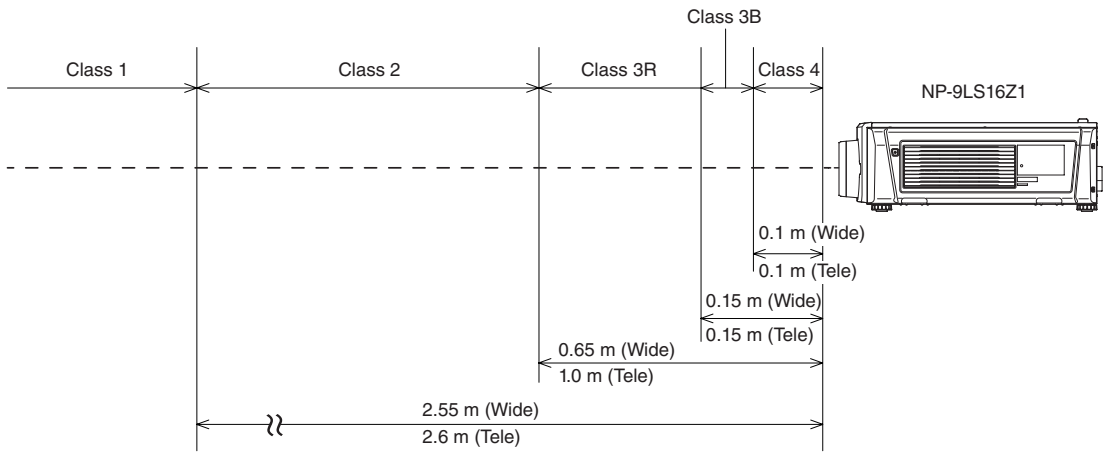
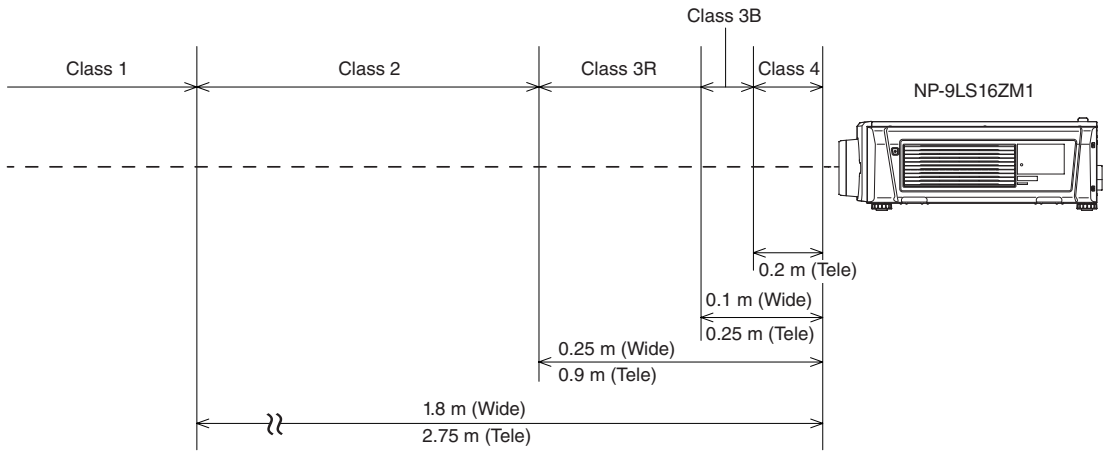

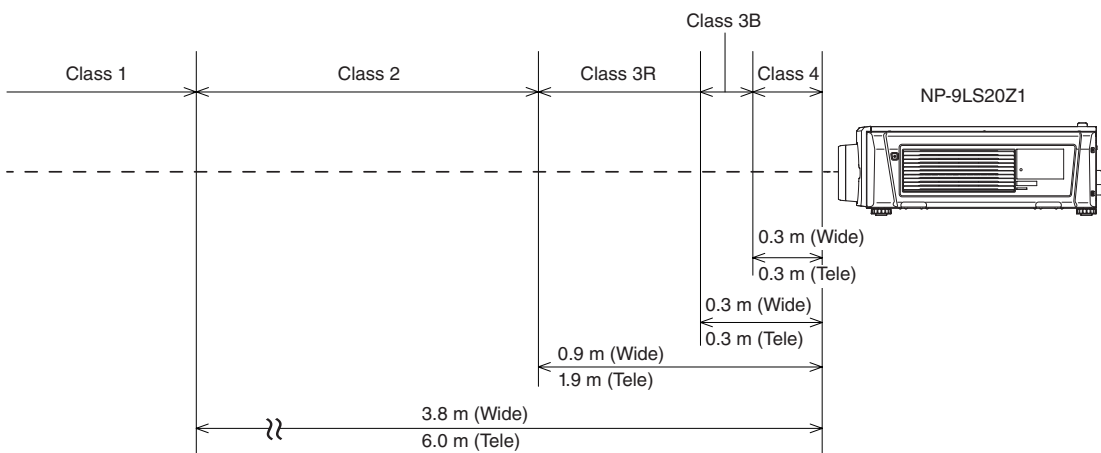
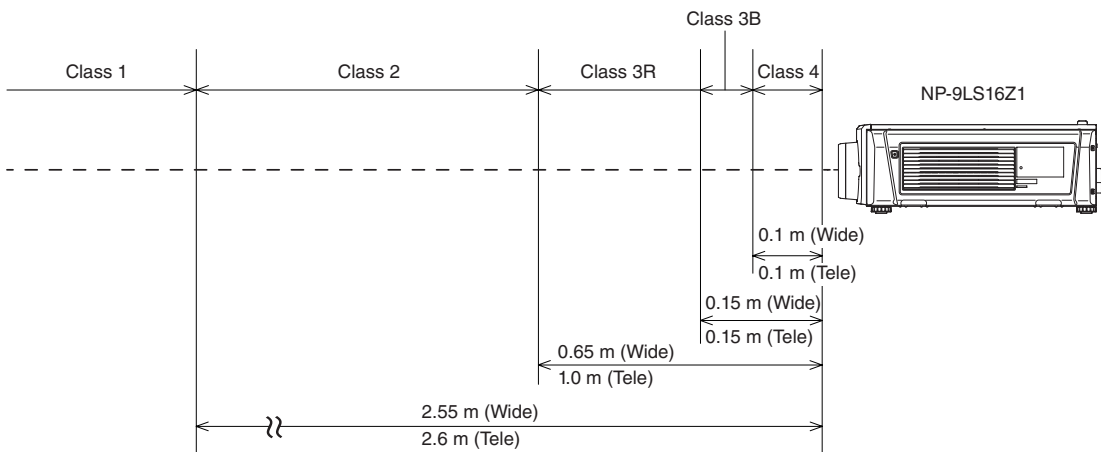
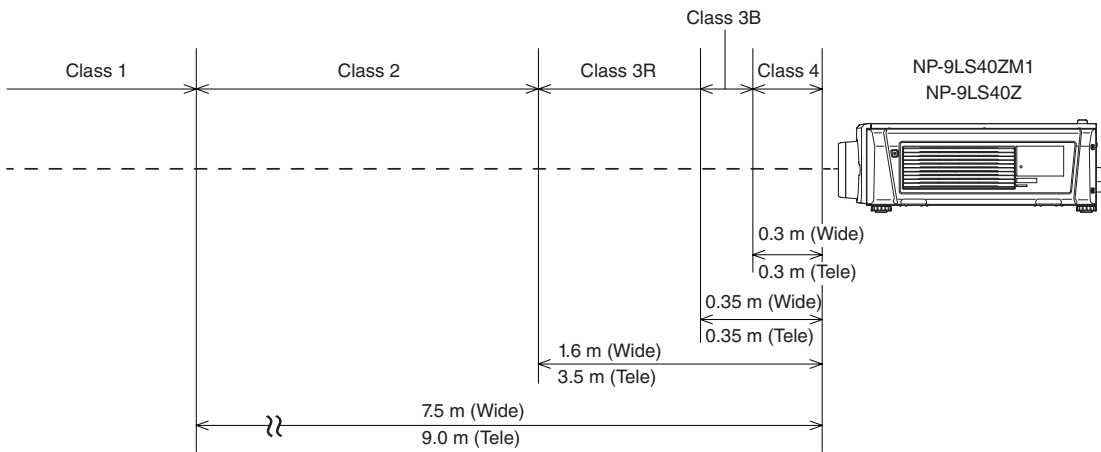

## Range of Laser Light Emissions

The following range indicates the maximum range of emission of laser light.

Horizon angle: H

[Degree]

Lens	Zoom	
	Tele	Wide
NP-9LS12ZM1	15.7	22.1
NP-9LS13ZM1	13.3	20.2
NP-9LS16ZM1	10.1	16.6
NP-9LS16Z1	13.5	16.9
NP-9LS20ZM1	7.2	13.2
NP-9LS20Z1	10.1	13.2
NP-9LS40ZM1	4.4	6.8
NP-9LS40Z1		

Vertical angle: V

[Degree]

Lens	Zoom	
	Tele	Wide
NP-9LS12ZM1	8.5	12.2
NP-9LS13ZM1	7.1	11.0
NP-9LS16ZM1	5.4	9.0
NP-9LS16Z1	7.1	9.1
NP-9LS20ZM1	3.8	7.1
NP-9LS20Z1	5.4	7.1
NP-9LS40ZM1	2.3	3.6
NP-9LS40Z1		

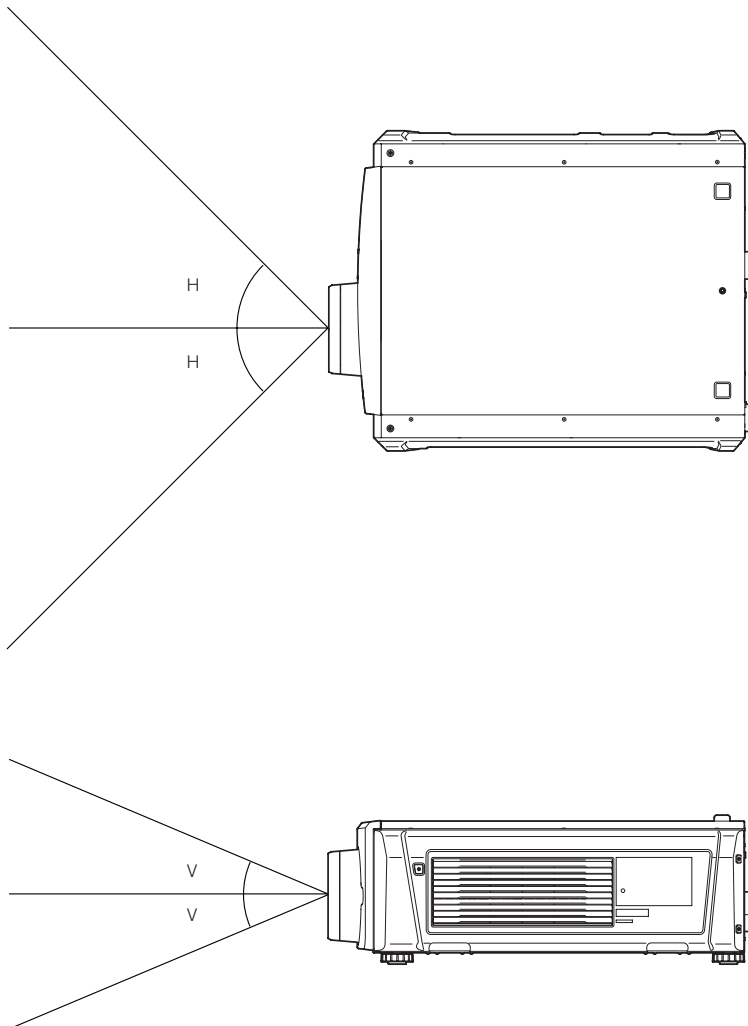

## Laser radiation range/No entry range (HD:Hazard distance)

- The below table describes the radiation range of emitted light by the projector that is classified as Risk Group 3 (RG3) of IEC 62471.
- Please keep within bounds for installing the projector.
  - Install a barrier for preventing human eyes from entering the RG3 area.
  - For the barrier installation position, keep horizontal safety zone over 1 m from the RG3 area.
  - In case to install the projector over head, keep over 2 m (2.5 m for USA) distance at least between the floor surface and the RG3 area.

Lens	HD [m]	H [m]	V [m]
NP-9LS12ZM1	2.8	1.63	0.86
NP-9LS13ZM1	3.5	1.67	0.88
NP-9LS16ZM1	4.2	1.56	0.82
NP-9LS16Z1	3.7	1.81	0.96
NP-9LS20ZM1	4.7	1.21	0.64
NP-9LS20Z1	5.2	1.91	1.01
NP-9LS40Z	10.0	1.58	0.83
NP-9LS40ZM1			

### When installed on a floor or a desktop

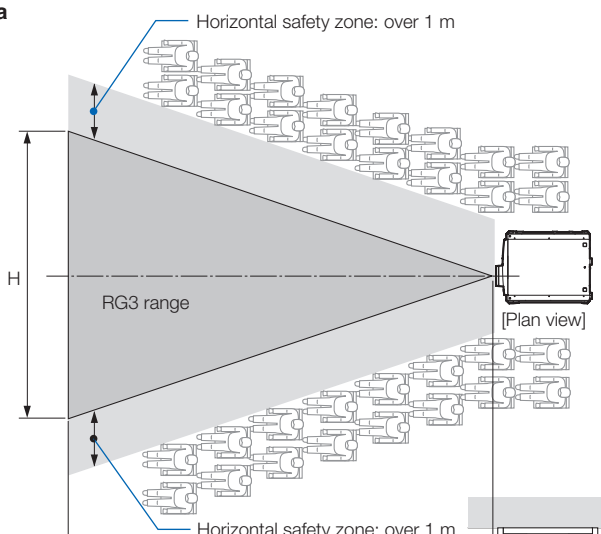

### When installed on a ceiling

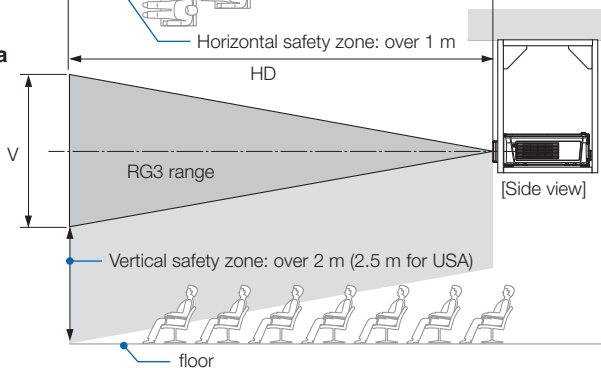

\* If lens shift is utilized, please consider the shift of projected image according to the volume of lens shift.



## **CAUTION**

Please heed all precaution for safety.

### **To install the projector**

- For planning the layout of the projector, make sure to take safety measures instructed on the installation manual.
- In order to refuse danger, install either a wall outlet within easy reach for pulling out the power plug in emergency or a device as a breaker to shut down the power supply to the projector.
- Take safety measures preventing human eyes from entering the RG3 area.
- Considering the installation place, select an appropriate lens and secure safety zone that is determined for each lens. For operation on the powered projector as light adjustment, make sure appropriate safety measures have been taken.
- Check the validity of taken security measures if appropriate safety zone based on the installed lens is secured. Periodically check the validity and keep these results.
- Educate the administrator of the projector (operators) about safety before starting to operate the projector.

### **To use the projector**

- Instruct the administrator of the projector (operators) to perform inspections before powering on the projector. (Including the safety check against emitted light by the projector)
- Instruct the administrator of the projector (operators) to be in circumstances able to control the projector whenever the projector is powered on for an emergency.
- Instruct the administrator of the projector (operators) to keep the installation manual, user's manual and inspection records to a place where they can take these documents out easily.
- Instruct them to clarify if the projector is conformed to standards of each country and region.



# Table of Contents

---

<b>Important Information .....</b>	<b>2</b>
<b>1. What's in the Box? and the Names of the Projector Parts.....</b>	<b>18</b>
1-1. Features.....	18
1-2. What's in the Box? .....	20
1-3. Names of the Projector Parts .....	22
<b>2. Installation and Connection.....</b>	<b>29</b>
2-1. Steps for setting up and connecting .....	29
2-2. Connecting the Power Cable .....	30
2-3. Connecting the image input terminals.....	34
2-4. Connecting the various control terminal .....	34
<b>3. Projection of Images (Basic Operation).....</b>	<b>35</b>
3-1. Steps of projecting images.....	35
3-2. Turning your projector on.....	36
3-3. Selecting the title of input signal.....	38
3-4. Adjusting the position and the size of projected screen.....	39
3-5. Preventing misoperations .....	43
3-6. Turning on/off the light with the projector turned on .....	44
3-7. Turning your projector off .....	45
<b>4. Using Menus .....</b>	<b>47</b>
4-1. Basic operation with adjustment menus.....	47
4-2. Table of adjustment menus .....	52
4-3. Title Select .....	53
4-4. Configuration .....	54
4-5. Title Setup .....	56
4-6. Information .....	56
<b>5. Maintenance of Your Projector .....</b>	<b>60</b>
5-1. Cleaning the Cabinet.....	60
5-2. Cleaning the Lens .....	61
<b>6. Appendix .....</b>	<b>62</b>
6-1. Troubleshooting.....	62
6-2. Indicator display list .....	63
6-3. Operation using an HTTP browser .....	66
6-4. Writing of the log file (Save Information) .....	68
6-5. Outline Drawing .....	71
6-6. Specifications.....	73
6-7. Power Cable .....	75
6-8. Pin Assignment and Functions of Terminal .....	77
6-9. Related products list.....	84

---

---

# 1.

# What's in the Box? and the Names of the Projector Parts

---

---

## 1-1. Features

- **DLP Cinema® projector**

Complies with the strict projection standards defined by the Digital Cinema Initiatives (DCI) industry group in the United States using leading imaging technology of NEC. It also supports 3D projection and high frame rates (HFR).

- **Employs a long life laser light source**

The projector employs a newly developed laser light source offering excellent reliability and redundancy. Since the laser light source has a long life (approx. 30,000 hours), this delivers low cost operation by removing the need for maintenance such as replacing and adjusting the light module over extended periods of time. Furthermore, it reduces the risk of the light source suddenly shutting off and leaving a black screen.

- **Delivers reduced installation space and increased freedom through a more compact and lightweight body**

The use of a 0.69" DLP cinema chip together with integration of the light module into the projector main unit both delivers a reduced installation area as well as improving the degree of freedom of installation. A wide variety of optional lenses (sold separately) are also available for the projector in order to support a wide variety of installation methods (a lens is not mounted when the projector is shipped from the factory).

- **Equipped with easy to use functions**

(1) Lens memory function and light memory function that can be operated with one touch.

The projector is equipped with a lens memory function that can save the zoom position and shift position of the lens and a light memory function that can save the brightness setting separately for each input signal. This makes it possible to project using preconfigured settings simply by selecting the signal when projecting multiple different input signals each with different screen size and brightness settings (Refer to "6-9. Related products list" (page 84) for details on the lenses that support the lens memory function).

(2) Built-in automatic adjustment function that makes the brightness and color of the light source uniform

Degradation of brightness and variations in color that occur as the light source is used for longer periods of time are kept to a minimum (the period over which variations in brightness can be limited varies depending on the brightness setting).

## 1. What's in the Box? and the Names of the Projector Parts

---

(3) Frequently used titles can be registered in preset buttons

The projector has been equipped with 8 preset buttons that make it easy to select registered title (input signal). To this projector, 100 titles at most can be registered (input signal registration). Among the registered titles, any 16 titles can be assigned to the preset buttons.

(4) You can operate and configure the projector via a network from a PC

You can operate and configure the projector via a network from a PC by using the separately supplied software Digital Cinema Communicator (DCC) for S2.

- **Advanced Dust Protection**

A dust control shield is arranged between each DMD chip of R, G and B, and the spectroscopic/condenser prism. It prevents dust and dirt in the air, and oily particles in smoke associated with event halls from coming into contact with the face of the DMD and causing operating problems.

## 1-2. What's in the Box?

Check the content of the accessories.

### 1-2-1. Projector

Projector

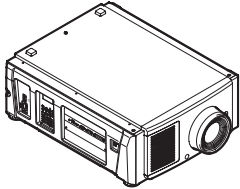

Power cable stopper

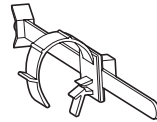

Service door key x 2



Keys for administrator x 2



CD-ROM (User's Manual)

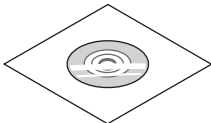

Important Information

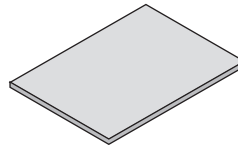

Control cable (6m x 1)

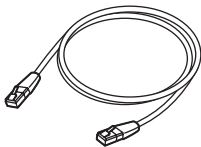

Retainer for Chiller unit

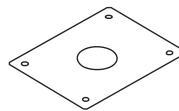

Maintenance key for chiller unit

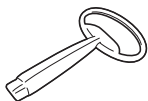

Hose for chiller unit (2 m x 2, 5 m x 2)



### 1-2-2. Chiller unit (NP-17CU01)

Chiller unit (NP-17CU01)

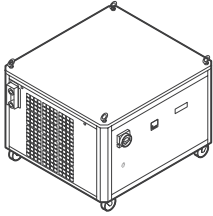

.....  
**TIP** In the event that you did not receive all of the accessories outlined above, or some are damaged, contact your dealer/  
distributor.  
Differs slightly from the drawings in this manual, but there is no problem in actual use.  
.....

## 1-3. Names of the Projector Parts

### 1-3-1. Front of the projector

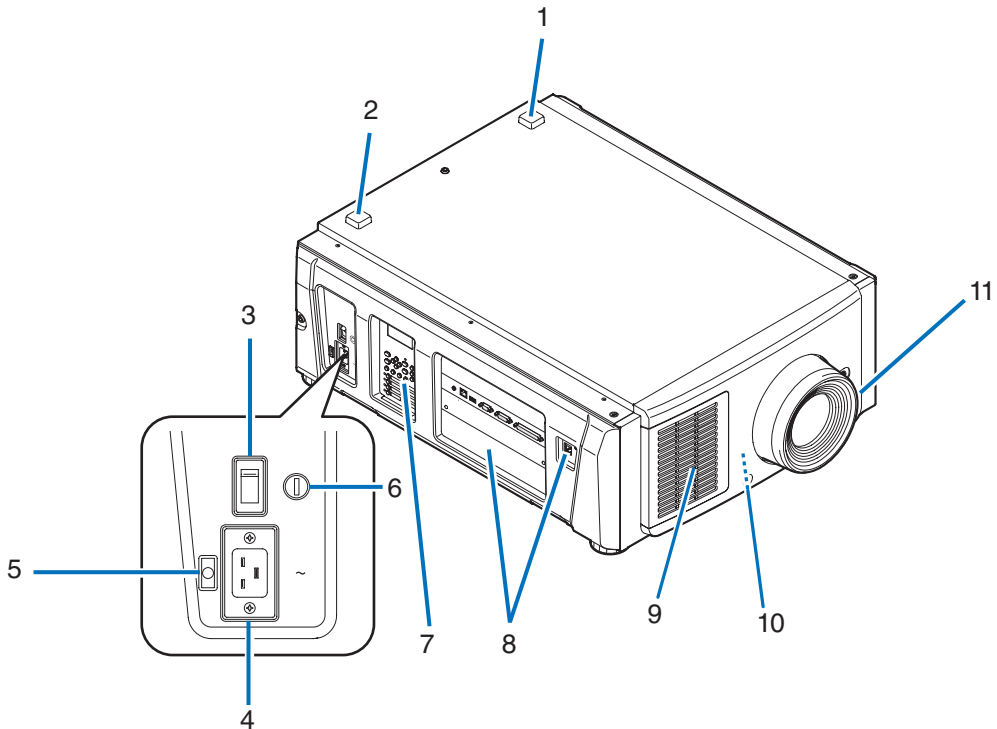

**1. LIGHT status indicator**

Displays the status of the light source. The indicators turn on when the light source is on and turn off when the light source is off (See page 65).

**2. SYSTEM status indicator**

These indicate the status of the projector. When the projector is operating normally, these light/blink in green or orange. When an error occurs, they light/blink in red. When an error occurs, check the contents of the display on the LCD screen. (See page 65)

**3. Main power switch**

While AC power is being supplied, set the main power switch to ON position (1), then your projector will enter a standby state.

**4. AC input**

Connects to the AC power cable. The AC power cable is not an accessory. Consult with your dealer/distributor about the AC power cable.

**5. Power cable stopper**

Prevents the power plug from falling out from the projector.

**6. Switch for administrator**

The projector can be operated normally by inserting the administrator key vertically and turning it to the horizontal direction. At this time, the administrator key cannot be removed. The projector will not function unless the administrator key is inserted.

**7. Control panel**

On the control panel, power to your projector is turned on or off, titles are selected, and various adjustments are made of projected screen. (See page 27)

**8. Connection terminals**

Various image signal cable are to be connected here. (See page 26)  
You can expand signal input terminals by installing the optional board.

# 1. What's in the Box? and the Names of the Projector Parts

Contact your dealer/distributor for more information on separately sold optional products.

## 9. Air inlet

The air inlet for cooling inside the projector. Do not cover.

## 10. Remote interlock connector (inside front of projector)

This port is for safely using the laser in this device. It is used to externally control the laser illumination in the projector. Consult with your dealer/distributor about using this.

## 11. Lens (optional)

Images are projected from the lens. Request your dealer/distributor to install or replace the lens.

**NOTE** Do not cover the air inlets and outlet while the projector is in operation. Insufficient ventilation leads to a rise of the internal temperature and may cause a fire or malfunction.

## 1-3-2. Rear of the projector

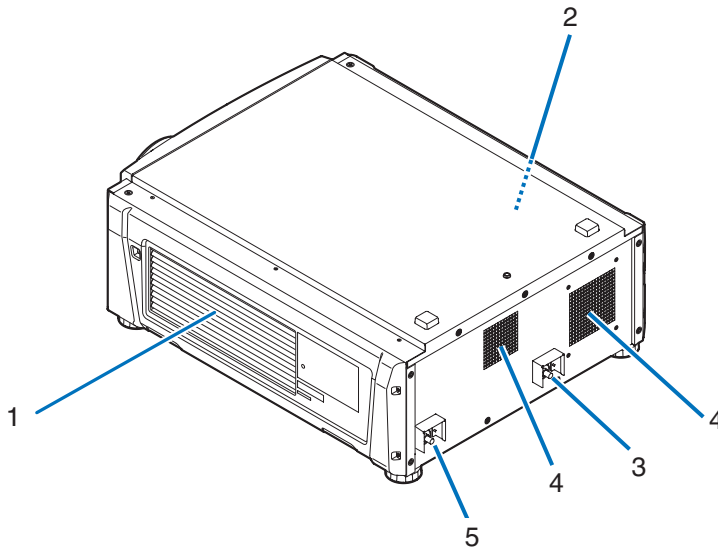

## 1. Air inlet

The air inlet for cooling inside the projector. Do not cover.

## 2. Buzzer (inside rear of projector)

The buzzer rings when the power is turned on or an error has occurred.

## 3. Hose attachment port (IN)

Connects to the attachment port (OUT) of the chiller unit using the hose for the chiller unit. Request your dealer/distributor to attach or detach the hose.

## 4. Air outlet

The air outlet to exhaust heat inside the projector. Do not cover.

## 5. Hose attachment port (OUT)

Connects to the attachment port (IN) of the chiller unit using the hose for the chiller unit. Request your dealer/distributor to attach or detach the hose.

**NOTE** Do not cover the air inlets and outlet while the projector is in operation. Insufficient ventilation leads to a rise of the internal temperature and may cause a fire or malfunction.

### 1-3-3. Bottom of the projector

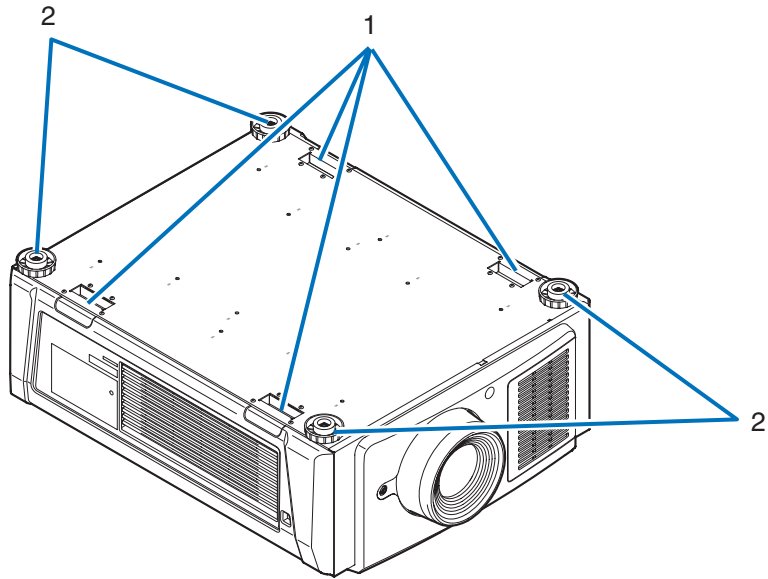

**1. Handle (4 locations)**

Handles for moving the projector.

**2. Level adjusters (in 4 positions)**

In the ordinary installation, you can adjust the projector inclination at 4 positions.



### 1-3-4. Chiller unit (NP-17CU01)

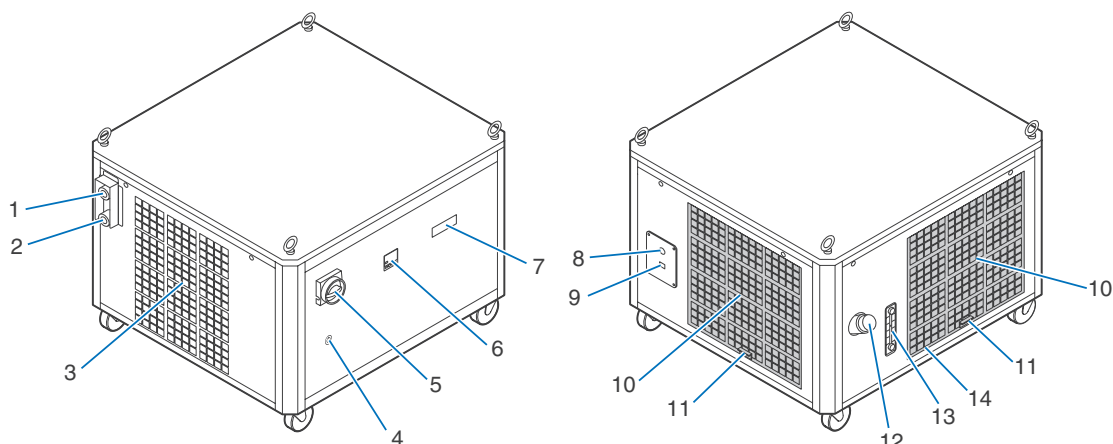

**1. Coolant inlet of chiller**

Connects to the attachment port (OUT) of the projector using the hose for the chiller unit. Request your dealer/distributor to attach or detach the hose.

**2. Coolant outlet of chiller**

Connects to the attachment port (IN) of the projector using the hose for the chiller unit. Request your dealer/distributor to attach or detach the hose.

**3. Air outlet**

The air outlet to exhaust heat inside the chiller unit. Do not cover.

**4. Keyhole**

**5. Emergency stop switch (AC power switch)**

Allows you to immediately stop the chiller unit (emergency stop state) by turning the switch when a malfunction occurs while the projector or chiller unit is in operation, or in the case of an emergency (a person enters the laser irradiation range, earthquake, fire, etc.). In the emergency stop state, the projector switches to the standby state.

**6. Temp. Controller**

Displays the chiller unit temperature.

**7. Status display**

Displays operating state and error status of the chiller unit.

**8. Hole for AC power line**

The AC power line will be passed through into this hole. And it will be connected inside in chiller unit. The AC power line is not included. Therefore request your dealer/distributor to attach or detach the AC power line.

**NOTE** Power cord minimum wire diameter must be 14 AWG.

**9. Connector for communication line (RJ-45)**

Connects the control cable in order to monitor the state of the chiller unit from the projector and control ON/OFF.

**10. Air inlet**

Draws in external air to prevent the chiller unit from internal overheating. Do not block.

**11. Air filter**

Periodically clean the air filter with a vacuum cleaner.

**12. Filler inlet for coolant**

Replenishes the cooling fluid.

**13. Coolant flow meter**

Allows you to check the cooling fluid level.

**14. Drain port (Inside)**

Drains the cooling fluid.

### 1-3-5. Connection terminals

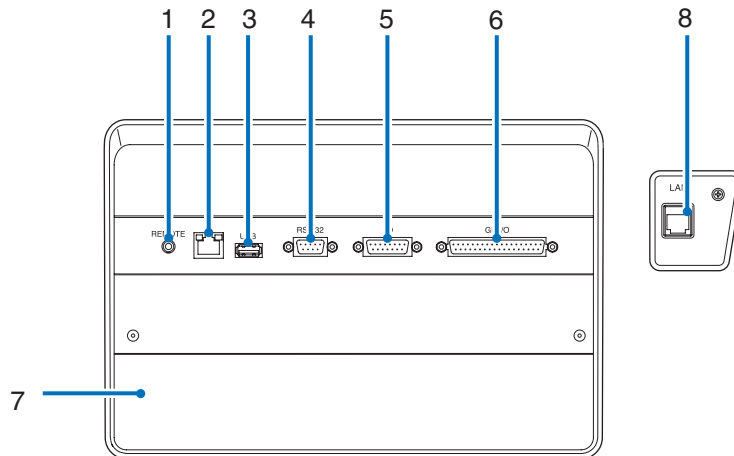

**1. Service terminal (REMOTE) (Stereo mini)**

This terminal is used for service purpose only.

**2. Ethernet port (LAN) (RJ-45)**

The port for interfacing with an image signal server or controlling the projector from a PC via a network. Connect the projector and the PC with a commercially available Ethernet cable (10/100/1000Base-T).

**3. USB port (USB) (type A)**

The port for the projector maintenance.

**4. PC control terminal (RS-232) (D-sub 9P)**

The terminal for operating the projector from a PC via an RS-232C or for service personnel to set data for the projector. Connect the projector and the PC with a commercially available RS-232C straight cable.

**5. 3D terminal (3D) (D-sub 15P)**

The terminal for connecting a 3D image system to the projector. (See page 83)

**6. External control terminal (GP I/O) (D-sub 37P)**

The terminal for externally controlling the projector or connecting a 3D image system to the projector. (See page 78)

**7. Slot**

The slot is used for an image media block (IMB). Contact your dealer/distributor for an installation of IMB.

Refer to the IMB instruction manual for details on IMB.

**8. Chiller unit control port (RJ45)**

Connects the control cable in order to monitor the state of the chiller unit from the projector and control ON/OFF.

## 1-3-6. Control panel

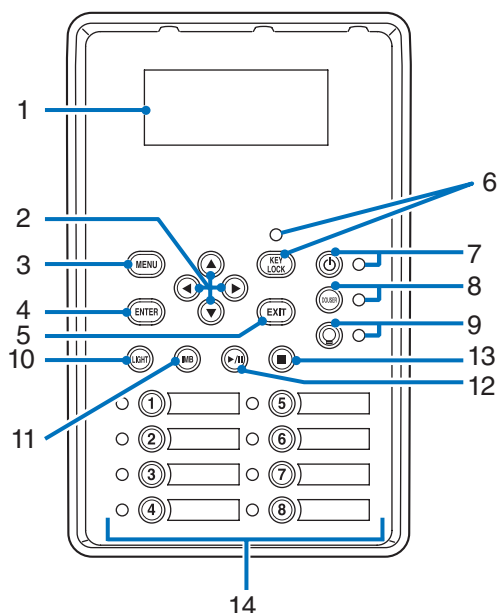

### 1. LCD screen

The LCD screen displays menus and setting values for the projector operations.

### 2. ▲/▼/◀/▶ (UP/DOWN/LEFT/RIGHT) buttons

Press these buttons to select a menu item while a menu is displayed.

### 3. MENU button

Press this button to display the menu for various settings and adjustments. (See page 52)

### 4. ENTER button

Press this button to select the menu item.

### 5. EXIT button

Press this button to return to the previous menu item.

### 6. KEY LOCK button

Press this button to lock (KEY LOCK) the buttons on the control panel. Buttons on the control panel do not function while KEY LOCK is on.

Pressing the KEY LOCK button for one second or longer while KEY LOCK is off locks the buttons.

Pressing the KEY LOCK button for one second or longer while KEY LOCK is on unlocks the buttons. (See page 43)

**NOTE** KEY LOCK becomes automatically on if no control panel operation takes place in the standby state for 30 seconds by default. (See page 43)

### 7. POWER button

Press this button for more than three seconds to turn on or off (standby) the projector. (See page 64)

In order to start up the projector, turn on the main power switch for the projector to set the projector in the standby state. (See page 36)

### 8. DOUSER button

Press this button to open and close the douser. (See page 64)

### 9. LIGHT ON/OFF button

Press this button for five seconds or longer to turn on or off the light source while the projector is on. (See page 44)

### 10. LIGHT button

Press this button to display the light source adjustment menu. (See page 42)

## 1. What's in the Box? and the Names of the Projector Parts

---

### 11. IMB button (planned to be supported in a future update)

This button is operable when the media block is installed in the projector.

Press this button to display the operation menu of the media block.

### 12. Play/pause button (planned to be supported in a future update)

This button is operable when the media block is installed in the projector.

Press this button to play or pause the image contents.

### 13. Stop button (planned to be supported in a future update)

This button is operable when the media block is installed in the projector.

Press this button to stop playing the image contents.

### 14. Preset buttons

Press the preset button to select a title (input signal) assigned to each button. Up to 100 titles (input signals) can be registered to this projector, and any 16 titles from them can be assigned to the preset button. Please request your dealer to register and change the titles of the buttons as required.

The preset button indicators show their assigned title or selection status. (See page 63)

.....  
**TIP** To select a title allocated to one of the preset buttons, use the following procedure.

- To select a title allocated to one of "Preset Button1" to "Preset Button8"

Press the button which corresponds to the number of the preset button (button <1> to <8>).

- Press the <1> button to select the "Preset Button1".
- Press the <8> button to select the "Preset Button8".

- To select a title allocated to one of "Preset Button9" to "Preset Button16"

Press the preset button (button <1> to <8>) while holding down the UP button.

- Press the <1> button while holding down the UP button to select the "Preset Button9".
  - Press the <8> button while holding down the UP button to select the "Preset Button16".
- .....

---

---

# 2.

## Installation and Connection

---

---

### 2-1. Steps for setting up and connecting

Use the following steps for setting up your projector:

- **Step 1**

Setup the screen and projector and chiller unit. (Contact your dealer to carry out the setup.)

- **Step 2**

Connect the power cable to the projector. (See page 30)

- **Step 3**

Connect cables to the image input terminals. (See page 34)

Connect cables to the various control terminals. (See page 34)

### 2-2. Connecting the Power Cable

The power cable is not included with the projector. Use a power cable that meets the standards and power supply voltage of the country where you are using the projector. Ask your dealer for the power cable to select and purchase.

#### **WARNING**

Carefully read the contents described in this section before connection and connect the cables according to the proper procedure. Inappropriate handling may cause fatal, serious or other bodily injuries due to fire or electric shock.

#### **CAUTION**

- Before connecting the power cables, check that the main power switch of the projector is turned off. Implement the connection with AC power shut off.
- Be sure to ground the equipment to ensure safety. Use a power cable that meets the standards and power supply voltage of the country where you are using the projector (page 75), and always connect the equipment to the ground. If the ground is not connected, it may cause electrical shocks.
- When connecting the power cable plugs to the AC IN and the electrical outlet, securely insert the plugs all the way in. If the connection between the power cable plug and the electrical outlet is loose, the plug area may generate heat, causing burns and accidents.

#### **NOTE**

- Install the electric outlet nearby the projector main unit so that the power supply can be cut by unplugging the AC power cable.
- When plugging in or unplugging the AC power cable, make sure that the main power switch is pushed to the [O] position. Failure to do so may cause damage to the projector.
- Do not use a three-phase power supply. Doing so may cause malfunction.

**1** Connect the AC power supply cable.

Connect the AC power supply cable to the projector.

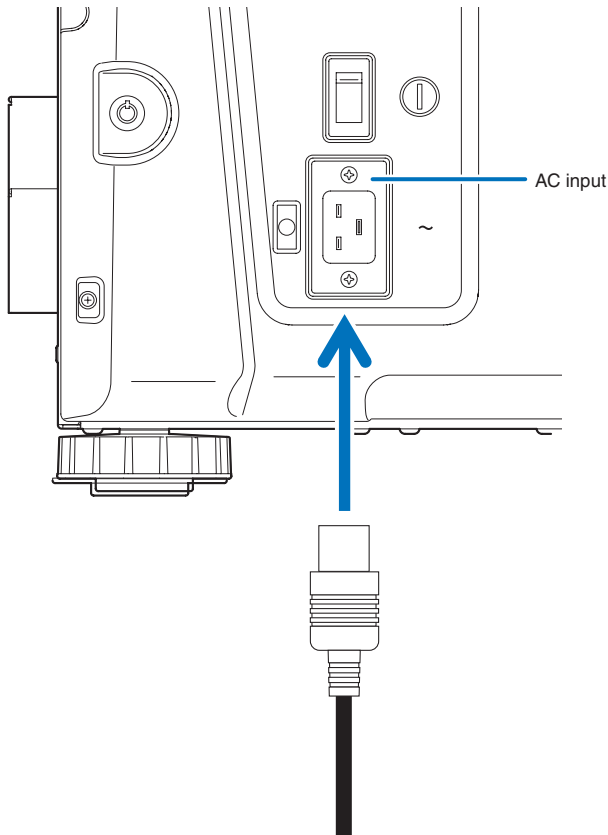

**2** Connect the power plug to the electrical outlet.

This completes the connection of the AC power supply cable.

## 2. Installation and Connection

### Using the supplied power cable stopper

To prevent the power cable from accidentally removing from the AC IN of the projector, attach the supplied power cable stopper to clamp the power cable.

#### CAUTION

- To prevent the power cable from coming loose, make sure that all the prongs of the power cable are fully inserted into the AC IN terminal of the projector before using the power cable stopper to fix the power cable. A loose contact of the power cable may cause a fire or electric shock.
- Do not bundle the power cable. Doing this could cause heat or a fire.

#### NOTE

- Do not clamp the power cable with other cables. Doing so can generate noise, which can affect adversely the signal cable.
- Be careful not to insert the band inversely. Once the band is attached, it cannot be removed from the slot.

### Attaching the power cable stopper

- 1** Insert the end of band of the power cable stopper into the slot next to the AC IN on the terminal panel.

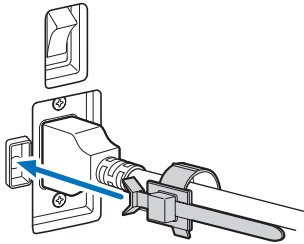

- 2** Use the power cable stopper to clamp the power cable.

Push the clasper to lock it.

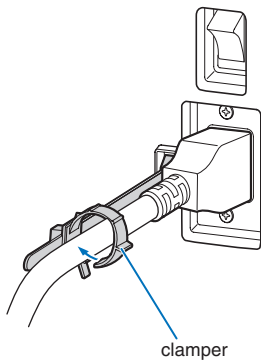



- 3 Slide the clamper to the hilt of the power cable.

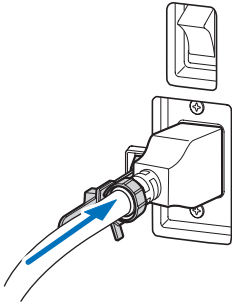

This completes the attachment of the power cable stopper.

### Removing the power cable from the power cable stopper

- 1 Push the clamper of the power cable stopper to unclasp it.

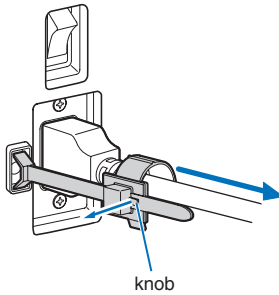

- 2 Push the power cable clamper to open it wide enough to pull out the power cable.

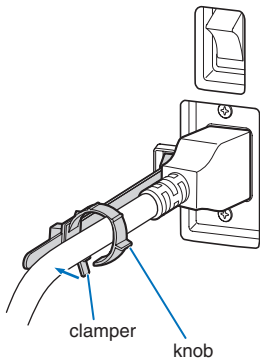

### CAUTION

The projector may become hot temporarily when the power is turned off or if the AC power is disconnected while the projector is projecting. Take care when handling the projector.

## 2-3. Connecting the image input terminals

The video input ports that can be used with the IMB are as follows. Refer to the instruction manual of the IMB for details on connecting the video input ports with external equipment.

NP-90MS02	HDMI input port	x 1
	3G SDI input port	x 2

## 2-4. Connecting the various control terminal

For control, your projector comes with such ports as the PC control terminal and the Ethernet port (RJ-45).

- PC control terminal (RS-232) ----- Use this terminal when controlling the projector in serial connection from a PC.
- LAN port (LAN)----- Use this port when controlling the projector in LAN connection from a PC.
- Chiller unit control port ----- Use this port to control the chiller unit from the projector through a LAN connection.

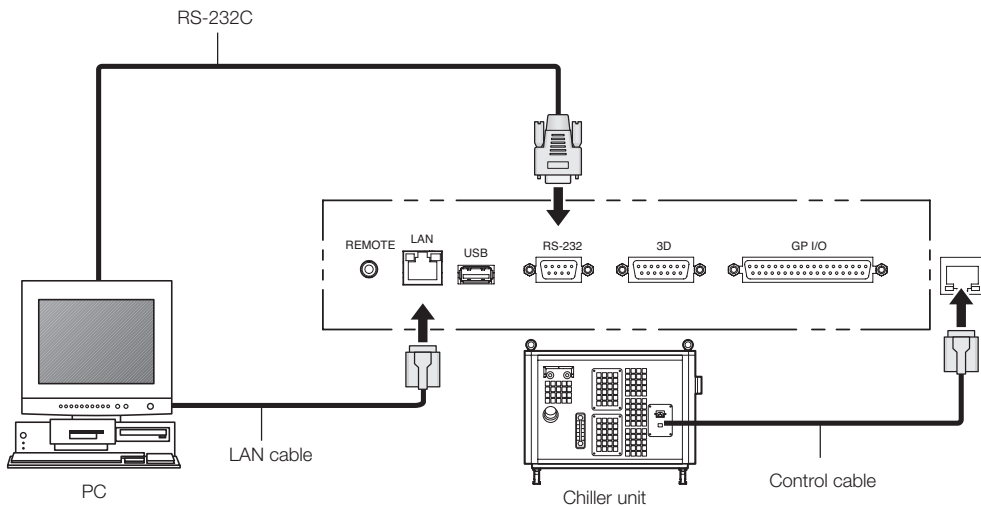

---

---

# 3.

## Projection of Images (Basic Operation)

---

---

### 3-1. Steps of projecting images

- **Step 1**

Turn on the power to the projector. (See page 36)

- **Step 2**

Select the title of input signal. (See page 38)

- **Step 3**

Adjust the position and size of the projected screen. (See page 39)

- **Step 4**

Turn off the power to the projector. (See page 45)

## 3-2. Turning your projector on

- Preparation:**
- Connect the power cable to the projector (see page 30) and chiller unit.
  - Supply AC power to the projector and chiller unit.

- NOTE**
- Turn off the main power switch to the projector when supplying or cutting AC power to the projector. Supplying or shutting down the AC power while the main power switch is on will damage the projector.
  - Turning on and off the projector involves a two-step operation; the “main power switch” and the “POWER button”.
  - Turning power on. (See this page)
    - [1] Turn on the “main power switch” of the projector.  
Your projector is set in a standby state.
    - [2] If KEY LOCK is on, press the KEY LOCK button for one second or longer.  
KEY LOCK is off and buttons on the control panel become operable.
    - [3] Press the POWER button three seconds or longer.  
Your projector and chiller unit is turn on.
  - Turning power off. (See page 45)
    - [1] Press the POWER button three seconds or longer.  
Your projector is set in a standby state.
    - [2] Turn off the “main power switch” of the projector.  
Your projector and chiller unit is turned off.

- 1** Remove the lens cap.
- 2** Turn ON the emergency stop switch (AC power switch) of chiller unit.
- 3** Insert the administrator key vertically and turn it to the horizontal direction. The administrator key can no longer be removed. The projector will not function unless the administrator key is inserted.
- 4** Turn on the main power switch on the side of the projector.

A buzzer will ring on the projector. The POWER button indicator will blink green and the SYSTEM status indicator will light orange (standby state). KEY LOCK becomes automatically on if no control panel operation takes place in the standby state for 30 seconds by default. Buttons on the control panel do not function while KEY LOCK is on. (See page 43)

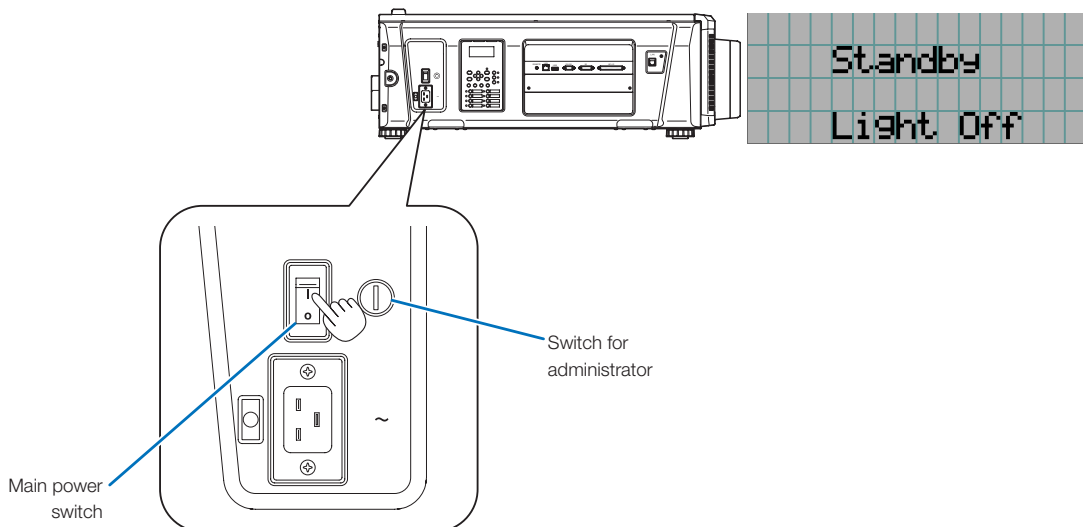

**5** If KEY LOCK is on, press the KEY LOCK button for one second or longer.

KEY LOCK becomes off. The KEY LOCK button indicator turns off and buttons on the control panel become operable. (See page 43)

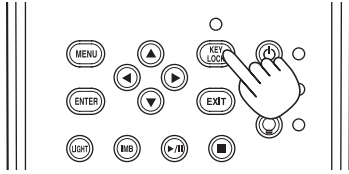

**6** Press the POWER button on the control panel of your projector three seconds or longer.

Your projector is turn on.

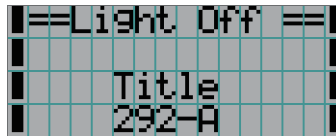
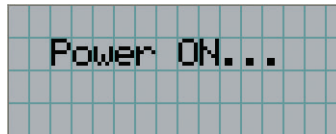
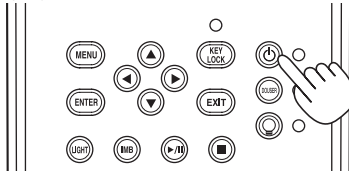

When the startup of the projector completes, the status of the POWER button, DOUSER button, LIGHT ON/OFF button, and preset button (button <1> to <8>) changes as follows.

POWER button	Lit green
DOUSER button	Initial settings: Off (douser is off)
LIGHT ON/OFF button	Initial settings: Blinking green (light source is off)
Button <1> to <8>	The preset button which was last selected is lit green

**7** Press the LIGHT ON/OFF button on the control panel for three seconds or longer.

The light source is turned on and the screen glows light about 15 seconds later.

The LIGHT ON/OFF button indicator blinks in cycles of 2 (and changes to steady green light 90 seconds later).

The douser is closed until the screen glows light (the DOUSER button indicator lights green). When the douser is open, the DOUSER button indicator turns off.

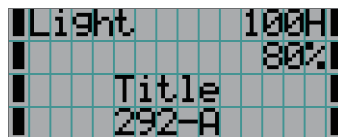
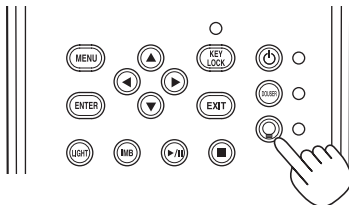

**NOTE**

- While your projector is on, be sure to have the lens cap and glass protector cap removed from the lens. Otherwise, the lens cap or glass protector cap may get deformed due to a heat buildup.
- In the following instances, the power to your projector cannot be turned on even if you press the POWER button.
  - When the inside temperature is abnormally high. The protective function prevents power from turning on. Wait some time (until the projector inside cools down) and then turn on the power.
  - When the SYSTEM status indicator is blinking in red without the light source lighting up after power-on. Your projector may be in trouble. Check the error display on the LCD screen and contact your dealer/distributor for instructions.
- Note that the image may sometimes flicker until the light has stabilized (5 to 10 minutes) after power-on. This is due to the characteristics of the light and is not trouble of your projector.

## 3-3. Selecting the title of input signal

This projector allows you to select pre-registered title (input signal) using the preset buttons on the control panel (up to 16 titles). Request your dealer/distributor for details on registering and changing titles. This section explains the steps for selecting registered titles.

- 1 Turn on the power to the image devices connected to the projector.
- 2 Press the MENU button.
- 3 Press the LEFT/RIGHT button to display “Title Select” on the LCD screen.

At each press of the LEFT/RIGHT buttons, the display will cycle as “Title Select” ↔ “Configuration” ↔ “(Title Setup)” ↔ “Information.”

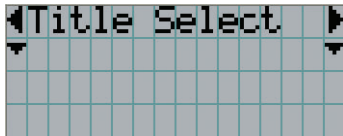

- 4 Press the DOWN button.

The title of the input signal is displayed.

- When you have made a wrong selection, press the UP button. A return will be made to the previous menu.

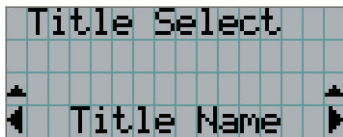

- 5 Press the LEFT/RIGHT buttons to display “Title of Signal to be Projected” on the LCD screen.

- 6 Press the ENTER button.

The title of the signal to be projected is selected.

- The (\*) mark on the LCD indicates that this is the currently selected item.

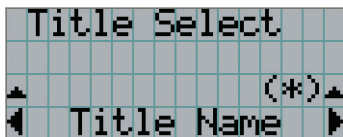

## 3-4. Adjusting the position and the size of projected screen

### 3-4-1. Displaying the test pattern

- 1 Press the MENU button, or select a test pattern from preset buttons (button <1> to <8>).

If you register the test patterns to the preset buttons (<1> to <8> buttons), select the test pattern according to "3-3. Selecting the title of input signal (See page 38)".

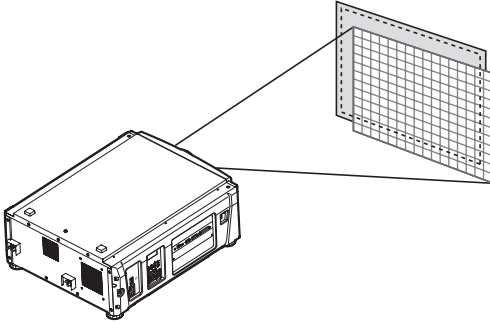

- 2 Press the LEFT/RIGHT button to display "Title Select" on the LCD screen.

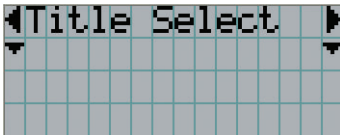

- 3 Press the DOWN button.

The title of the input signal is displayed.

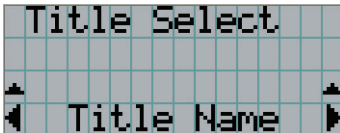

- 4 Press the LEFT/RIGHT button to display "TEST Pattern" on the LCD screen.

- 5 Press the DOWN button.

The LCD screen enters the mode where you can select a test pattern.

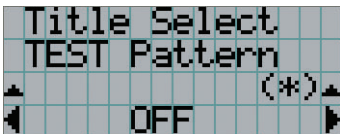

- 6 Press the LEFT/RIGHT button.

This switches the test pattern name displayed on the LCD screen.

### 3. Projection of Images (Basic Operation)

---

- 7 Display on the LCD the name of the test pattern to be projected, then press the ENTER button.

The test pattern is displayed.



To cancel the test pattern display, select the title of the signal to project or select the "OFF" test pattern.

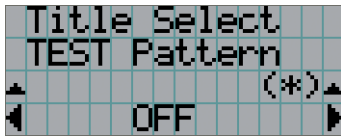

#### 3-4-2. Adjusting the position of the projected screen (Lens shift)

- 1 Press the MENU button.
- 2 Press the LEFT/RIGHT button to display "Configuration" on the LCD screen.
- 3 Press the DOWN button.
- 4 Press the LEFT/RIGHT button to display "Lens Control" on the LCD screen.
- 5 Press the DOWN button.

The screen ("Lens Position") to adjust the position of the projected screen is displayed.

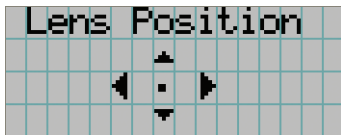

- 6 Press the UP/DOWN/LEFT/RIGHT button.

The position of the projected screen moves in the selected direction.

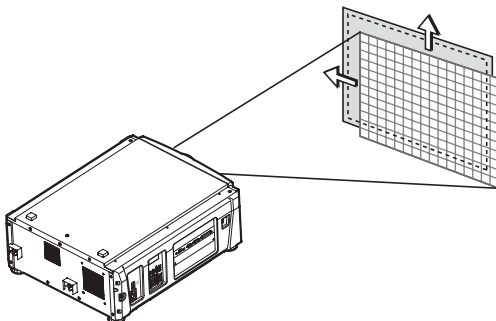

- 7 Press the EXIT button when adjustment is complete.

The display will return to a menu one level above (where "Lens Control" is displayed).



### 3-4-3. Adjustment of the size (zoom) and focus of the projected screen

- 1** Press the MENU button.
- 2** Press the LEFT/RIGHT button to display “Configuration” on the LCD screen.
- 3** Press the DOWN button.
- 4** Press the LEFT/RIGHT button to display “Lens Control” on the LCD screen.
- 5** Press the DOWN button.

The screen (“Lens Position”) to adjust the position of the projected screen is displayed.

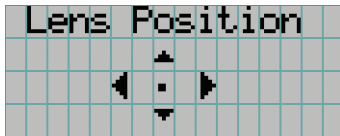

- 6** Press the ENTER button.

The screen to adjust the size and focus of the projected screen is displayed.

Press the ENTER button to switch the display between “Lens Position” and “Focus Zoom” adjustments.

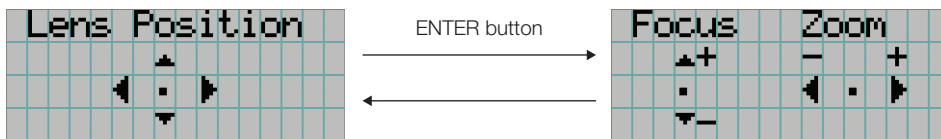

- 7** Adjust the size and focus of the projected screen.

Press the UP/DOWN button to adjust the focus.

Press the LEFT/RIGHT button to adjust the size.

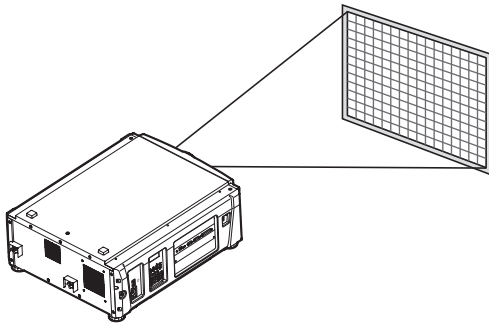

Focus  
(UP/DOWN button)

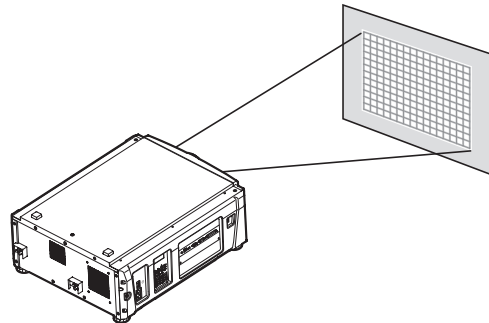

Zoom  
(LEFT/RIGHT button)

- 8** Press the EXIT button when adjustment is complete.

The display will return to a menu one level above (where “Lens Control” is displayed).

### 3. Projection of Images (Basic Operation)

#### 3-4-4. Adjusting the brightness of the projected screen (Light output)

**NOTE** If the internal temperature within the projector rises due to the temperature in the room being high, the light output may be automatically reduced. This is called "Thermal Protection Mode (Down Light Power)". When the projector is in the Thermal Protection Mode, the picture brightness decreases slightly. To clear Thermal Protection Mode, adjust the light output. Consult with your dealer/distributor for details.

**1** Press the LIGHT button.

The screen to adjust the light output is displayed.

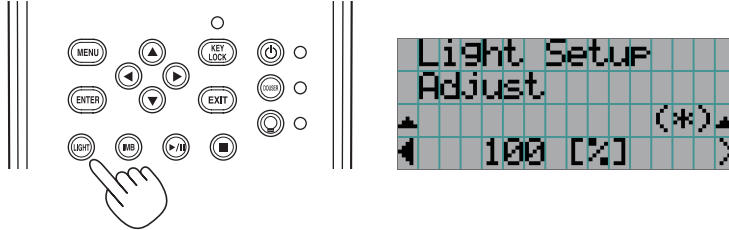

**2** Press the LEFT/RIGHT button to adjust the light output.

The specified adjustment value is applied.

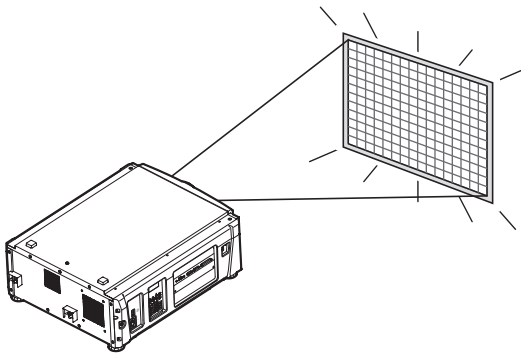

## 3-5. Preventing misoperations

Buttons on the control panel can be locked (KEY LOCK) to prevent misoperations. Buttons on the control panel do not function while KEY LOCK is on. KEY LOCK must be off to operate these buttons.

### NOTE

- KEY LOCK is automatically turned on in the following cases.
  - When the projector has entered the standby state by turning on the main power switch of the projector while the AC power is supplied.
  - When the projector has entered the standby state after turning off the power using the POWER button.
- The timing where KEY LOCK is turned on while the projector is in standby state depends on the “Auto Key Lock” setting in the adjustment menu.
  - When Auto Key Lock is enabled, KEY LOCK becomes automatically on if no control panel operation takes place in the standby state for 30 seconds. KEY LOCK becomes automatically on again even after KEY LOCK is turned off if no control panel operation takes place for 30 seconds.
  - When Auto Key Lock is disabled, KEY LOCK becomes automatically on when the projector enters the standby state; however, it stays off after KEY LOCK is turned off.

### 3-5-1. KEY LOCK setting

- Press the KEY LOCK button on the control panel for one second or longer.

KEY LOCK becomes on. The KEY LOCK button indicator lights orange. When you press a button on the control panel of the projector while KEY LOCK is on, “Panel is Locked. (KEY LOCK)” is displayed, and the button will not function. (See page 48)

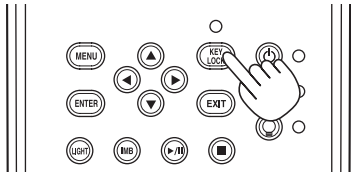

### 3-5-2. Turning KEY LOCK off

- Press the KEY LOCK button for one second or longer while KEY LOCK is on.

KEY LOCK becomes off. The KEY LOCK button indicator turns off.

## 3-6. Turning on/off the light with the projector turned on

**NOTE** The indicators on the control panel blink when the following operations are carried out. (See page 63)

- When you turn the light off  
The LIGHT ON/OFF button indicator blinks green. The light cannot be turned on while the LIGHT ON/OFF button indicator is blinking.

If you operate the POWER button or LIGHT ON/OFF button while the indicators are blinking, the LCD screen displays the warning screen below. The POWER button or LIGHT ON/OFF button becomes operable when the amount of time remaining reaches 0.

```
*Lamp not      *
available now!
left 83 sec
* < OK > *
```

### 3-6-1. Turning off the light

- Press the LIGHT ON/OFF button on the control panel for three seconds or longer.

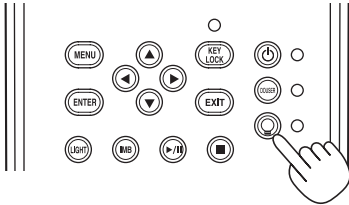

### 3-6-2. Turning on the light

- Press the LIGHT ON/OFF button on the control panel for three seconds or longer.

## 3-7. Turning your projector off

### 1 Press the POWER button on the projector control panel for three seconds or longer.

The light is turned off, the POWER button indicator blinks green, and the STATUS indicator blinks orange (cooling state). The fan will continue to rotate while cooling, and the amount of time remaining for cooling is displayed on the LCD screen. The cooling-off time is 90 seconds.

When the cooling is finished, the POWER button indicator turns off and the status indicator lights orange (standby state). KEY LOCK becomes automatically on if no control panel operation takes place in the standby state for 30 seconds by default. Buttons on the control panel do not function while KEY LOCK is on. (See page 43)

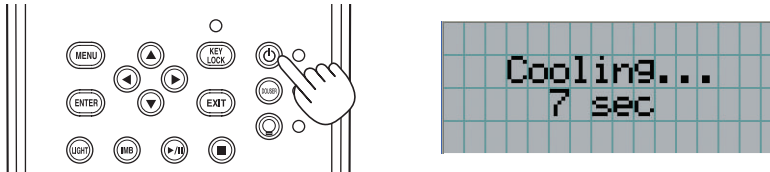

### 2 Wait till the projector enters standby state before turning off the main power switch of the projector.

Chiller unit main power is turned off.

The POWER button indicator is turned off and the main power is turned off.

### 3. Projection of Images (Basic Operation)

---

- 3 Return the laser administrator switch to the OFF position, then remove the laser administrator key.

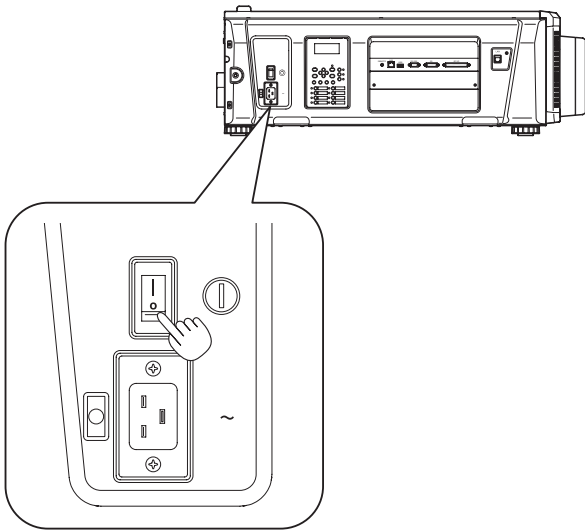

- 4 Turn OFF the emergency stop switch (AC power switch) of chiller unit.
- 5 Turn off the AC power to the projector and chiller unit.

**NOTE** In the following instances, do not turn off the main power switch or disconnect the AC power. Doing so can damage the projector.

- While projecting images
- While the fan is running after the power is turned off

---

---

# 4.

## Using Menus

---

---

### 4-1. Basic operation with adjustment menus



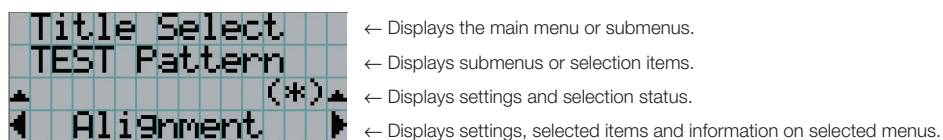

To adjust the projector, display the menu on the LCD screen of the projector control panel.

#### 4-1-1. Screen display

The menu display screen is composed of a menu display field (the upper two lines) and a setting item display field (the bottom two lines).



The meanings of symbols in the menu display screen are outlined below.

	Indicates that there is a menu of a higher level. Press the UP button to return to a menu one level above.
	Indicates that there is a selected item or menu at the same level. Press the LEFT/RIGHT button to display other selected items or menus.
	Indicates that there is a menu of a lower level. Press the DOWN button to display the menu one level below.
	Indicates that there are setting items of a higher or lower level. Press the UP button to return to a menu one level above. Press the DOWN button to display the setting item one level below.

## 4. Using Menus

---

When not displaying menus, the following screen is normally displayed.

### When in standby

When the projector is in a standby state (the main power switch in on), the following is displayed.

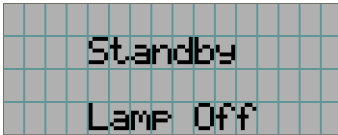

### When power is turned on

When the power is turned on, the following is displayed.

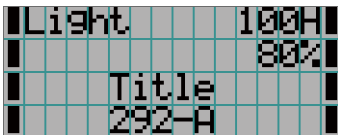

← Displays the hours of light source use.

← Displays the value of the light source output setting (%).

← Displays the selected title.

← Displays the selected video input port.

### When the power is turned off

When you press the POWER button on the control panel of the projector for 3 or more seconds, the projector starts cooling. When cooling finishes, the projector enters the standby mode. The amount of time remaining for cooling is displayed as shown below during cooling.

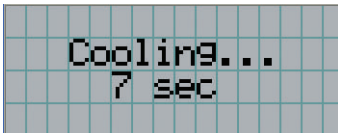

### When a button is pressed while the key lock function is on

If a button on the control panel is pressed while the key lock function is on, the following is displayed and the button will not function.

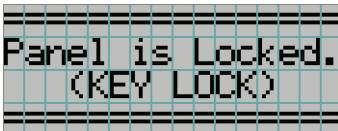



## 4-1-2. Operating menus

**Preparation:** Turn your projector on. (See page 36)

- 1** Press the MENU button on the control panel of your projector.

The menu is displayed in the LCD screen.



- 2** Press the LEFT/RIGHT buttons to display "Information."

At each press of the LEFT/RIGHT buttons, the display will cycle as "Title Select" ↔ "Configuration" ↔ "(Title Setup)" ↔ "Information."

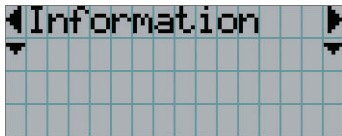

- 3** Press the DOWN button.

The submenu "Light Output" of "Information" is displayed.

The menu item can be selected by pressing the ENTER button instead of the DOWN button.

To return to the previous state, press the UP button, or the EXIT button.

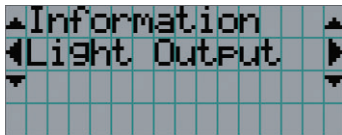

- 4** Press the LEFT/RIGHT button to select the submenu "Version."

At each press of the LEFT/RIGHT button, the display will cycle as "Light Output" ↔ "Lens Type" ↔ "Preset Button" ↔ "Usage" ↔ "Error Code" ↔ "Version" ↔ "IP Address" ↔ "Setup Date" ↔ "Option Status."

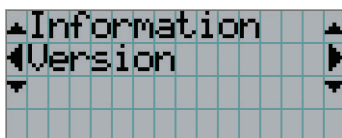

- 5** Press the DOWN button.

The submenu "System" another rank lower than "Version" is displayed.

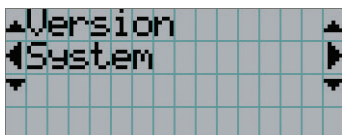

## 4. Using Menus

---

### 6 Press the DOWN button.

The submenu "BIOS" another rank lower than "Model" is displayed.

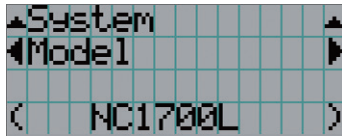

### 7 Press the LEFT/RIGHT button to select the submenu "Release Package."

At each press of the LEFT/RIGHT button, the display will cycle as "Model" ↔ "Serial No." ↔ "Release Package" ↔ "Kernel" ↔ "U-Boot" ↔ "System Files" ↔ "Cinema Firmware" ↔ "Cinema Data" ↔ "ICP Firmware" ↔ "ICP ConfigFile" ↔ "FMT FPGA" ↔ "Slave BIOS" ↔ "Slave Firmware" ↔ "Opt MCU" ↔ "Secure Processor" ↔ "Lens" ↔ "Laser Driver" and each version information is displayed.

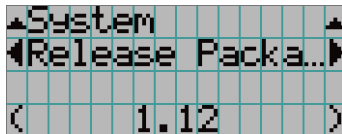

### 8 Press the UP button several times.

At each press of the UP button, the display will return to a menu one level above.

### 4-1-3. How to enter alphanumeric characters

Alphanumeric characters are entered for items, such as the log file of the specified period is written to USB memory. (See page 68)

Characters can be entered by pressing numeric buttons on the control panel on this projector.

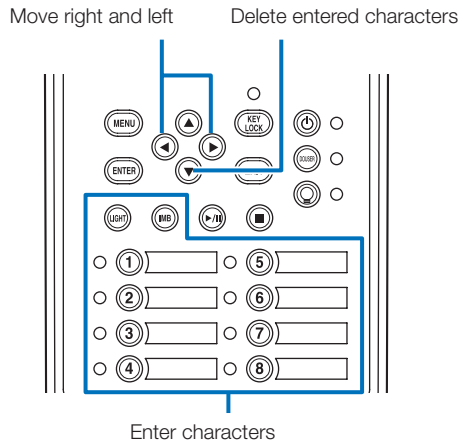

Characters can be entered by pressing each button as shown in the following table.

- To delete a character during entry, press the DOWN button.

#### [Example of Entry]

To enter "XGA" for example, use the following procedure:

- (1) Press the "8" button three times.  
V → W → X
- (2) Press the RIGHT button.
- (3) Press the "3" button.  
XG
- (4) Press the RIGHT button.
- (5) Press the "1" button.  
XGA

Button	Entered character
1	A → B → C → 1 → a → b → c → ! → ↑
2	D → E → F → 2 → d → e → f → " → ↑
3	G → H → I → 3 → g → h → i → # → ↑
4	J → K → L → 4 → j → k → l → \$ → ↑
5	M → N → O → 5 → m → n → o → % → ↑
6	P → Q → R → 6 → p → q → r → & → ↑
7	S → T → U → 7 → s → t → u → ' → ↑
8	V → W → X → 8 → v → w → x → ( → ↑
LIGHT	Y → Z → / → 9 → y → z → ? → ) → ↑
IMB	* → , → . → 0 → ; → : → + → - → ↑

## 4-2. Table of adjustment menus

Menus in parentheses are menus for our service personnel. Normally, these menus cannot be used.

Main menu	Submenu		Description	Reference page		
Title Select	"Title Memory Name"		Selects the title of the signal to be projected.	53		
	TEST Pattern		Selects the test pattern to be projected.	53		
Configuration	Light Setup	Adjust	Adjusts light brightness.	54		
	Lens Control	Lens Position	Adjusts the position of the projected screen.	54		
		Focus Zoom	Adjusts the size and focus of the projected screen.	54		
	Reset	(FactoryDefault)		Returns the settings to their default values. Selects between preset buttons and titles only, LAN settings only and all settings.	-	
		Filter Cleaning		Initializes the air filter usage time (for confirming the filter cleaning time).	55	
		(Fan Usage)		Initializes the usage time of the fan.	-	
		(Light Usage)		Initializes the usage time of the light source.		
		(Phosphor)		Initializes the usage time of the phosphor.		
		(Diffuser)		Initializes the usage time of the diffuser.		
		(Chiller)		Initializes the usage time of the chiller unit.		
		(Chiller Fan)		Initializes the usage time of the chiller unit fan.		
		(Douser Count)		Resets the number of times the douser has been used.	-	
	(Setup)	Douser Setup		Sets the douser open/close state.	-	
		Panel Key Lock		Locks the buttons on the projector's control panel so that they cannot be operated.	-	
		Auto Key Lock		Enables or disables Auto Key Lock.	-	
		3D Connector		Sets the signal input terminal for a 3D image system (3D terminal or GPI/O terminal). Sets the video input port for 3D video systems.	-	
		Off Timer		Sets the time until the projector power is turned off automatically.	-	
		Message		Sets the time to display the message indicating the light replacement cycle, air filter replacement cycle, and air filter cleaning cycle.	-	
		Silent Mode		Selects whether to use the status indicator, buzzer, indicators on the control panel and backlight.	-	
		Installation (Note)	(Option Slot)		Configures the device installed in slot (only when the projector is in standby mode).	-
	(Orientation)		Sets the projection method and cooling fan operating mode.	-		
	Lens Type (Note)		Sets the type of lens (supports or does not support the lens memory function) attached to the projector.	55		
	Lens Calibrate (Note)		Performs calibration on lens that support the lens memory function (only when the projector power is turned on).	55		
	Lens Center (Note)		Moves the lens shift position to the center (only when the projector power is turned on).	55		
	(Baudrate)		Sets the PC control connector (RS-232) data transmission speed (bps).	-		
	(Date/Time)		Sets the date and time on the projector.	-		
	(Fan Speed Mode)		Sets the cooling fan operating mode.	-		
	(Service Adj.)		(Only when the projector is in standby mode) This is used during shadow adjustment and lens mount adjustment (focus balance adjustment).			
	(LD Calibrate)		Performs calibration of the light module when the light module has been replaced (only when the projector power is turned on).	-		
	(Memory)	Light		The content of the selected light memory (light output power value) can be overwritten with the current settings.	-	
		Lens		The content of the selected lens memory can be overwritten with the current settings.	-	
	(Title Setup)	Preset Button	Preset Button 1-16	Sets the title to be assigned to the preset buttons (<1> to <8> buttons).	56	
	Information	Light Output		Displays the light source output setting.	56	
		Lens Type		Displays the lens type setting.	56	
		Preset Button	Preset Button 1-16		Displays the titles which are assigned to the preset buttons (<1> to <8> buttons).	57
		Usage		Displays information related to projector usage.	57	
		Error Code		Displays the currently occurring error.	57	
Version		System		Displays the model name and various version information about the projector.	58	
		IMB		Displays the vendor name and version information about the media block (IMB).	58	
IP Address		System		Displays the IP address of the projector.	58	
Setup Date		Displays the date when the projector was set up (starting date of the warranty period).		59		
Option Status		Displays the link status of the device mounted in slot and projector.		59		

## 4-3. Title Select

### 4-3-1. Title select (Title Memory)

Selects the title of the signal to be projected.

You can register up to 100 titles. You can also assign registered titles to the preset buttons (<1> to <8> buttons) on the projector's control panel and call them up directly using those buttons.

Request your dealer/distributor for details on registering and changing titles.

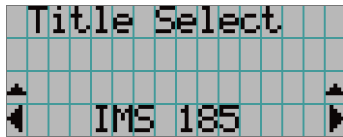

← Displays the currently selected item with asterisk (\*).

← Selects the title to be projected.

### 4-3-2. Test Pattern

Selects the test pattern to be projected.



← Displays the currently selected item with asterisk (\*).

← Selects the test pattern to be projected.

OFF, Alignment, Cross Hatch, Convergence, Red, Green, Blue, White, Black,  
White 50% [IRE], H-Ramp, Logo

## 4-4. Configuration

Please request your dealer/distributor to perform the settings.

### 4-4-1. Light Setup

#### Adjust

Adjusts the light output (brightness).

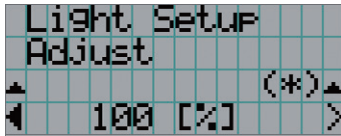

← Displays the current output power value (%) when the light rated output is 100%.

### 4-4-2. Lens Control

Adjust the position, size, and focus of the projected screen.

Press the ENTER button to switch the display between "Lens Position" and "Focus Zoom" adjustments. Press the EXIT button to return to a menu one level above.

#### Lens Position

Adjusts the position of the projected screen.

The projected screen moves in the selected direction as you press the UP/DOWN/LEFT/RIGHT button.

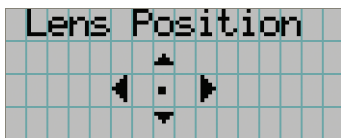

#### Focus Zoom

Adjusts the size (Zoom) and focus (Focus) of the projected screen.

Press the UP/DOWN button to adjust the focus.

Press the LEFT/RIGHT button to adjust the size of the projected screen.

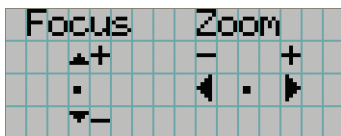

### 4-4-3. Reset

This is used to reset the light and air filter usage times.

#### Filter Cleaning

Resets the air filter usage time (for confirming the filter cleaning time).

- [1] Press the ENTER button, the confirmation screen will appear.
- [2] Select "Yes" in the confirmation screen, and then press the ENTER button to reset the filter usage time.

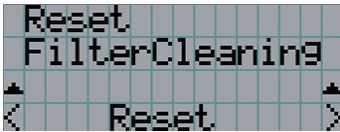

← Press the ENTER button to display the confirmation screen.

### 4-4-4. Installation

#### Lens Type

Sets the type of lens (supports or does not support the lens memory function) attached to the projector. This menu item is available only when you are logged into the projector with Advanced User or higher privileges.

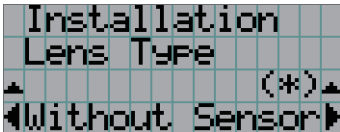

← Displays the currently selected item with asterisk (\*).

← Displays the setting.

Without Sensor	Selected when using a lens unit that does not support the lens memory function (default value).
With Sensor	Selected when using a lens unit that supports the lens memory function.

#### Lens Calibrate

Performs calibration on lenses that support the lens memory function. Once you have attached a lens that supports the lens memory function, always execute calibration. This menu item is available only when the projector power is turned on and you are logged into the projector with Advanced User or higher privileges.

**NOTE** This items cannot be used if Lens Type is set to "Without Sensor".

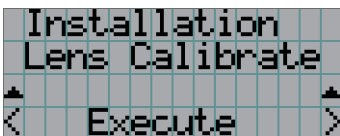

← Press the ENTER button to execute calibration.

#### Lens Center

To move the lens shift to the center position. The center position may slightly shift depending upon mounting conditions of the lens. This menu item is available only when the projector power is turned on and you are logged into the projector with Advanced User or higher privileges.

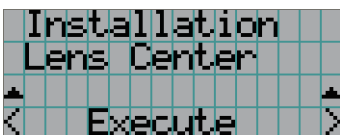

← Press the ENTER button to execute moving.

## 4-5. Title Setup

Sets the title to be assigned to the preset buttons (<1> to <8> buttons) (up to 16 titles).  
Request your dealer/distributor to perform the settings.

## 4-6. Information

Displays the hours of light use, the version information and error codes.

### 4-6-1. Light Output

Displays the value of the light source output setting (%).

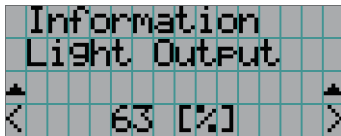

← Displays the current setting (%).

### 4-6-2. Lens Type

Displays the current lens type setting. The lens type setting is configured from "Lens Type" in the "Configuration" - "Installation" menu (page 54).

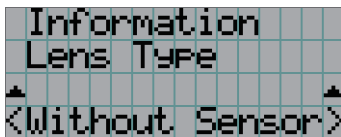

← Displays the current lens type setting.

Without Sensor	Using a lens unit that does not support the lens memory function.
With Sensor	Using a lens unit that supports the lens memory function.



### 4-6-3. Preset Button

Sets the title to be assigned to the preset buttons (<1> to <8> buttons) on the projector's control panel.

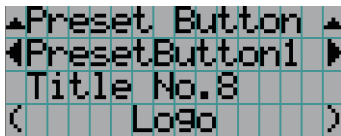

← Selects the preset button number whose contents you want to display.

← Displays the assigned title numbers.

← Displays the registered names of the assigned titles.

**TIP** To select a title allocated to one of "Preset Button9" to "Preset Button16", press the preset button while holding down the UP button. For example, to select the title allocated to "Preset Button9", press the <1> button while holding down the UP button.

### 4-6-4. Usage

Displays information related to the projector usage, such as the usage time of the projector, light, air filters, and fan, and information about the light replacement cycle.

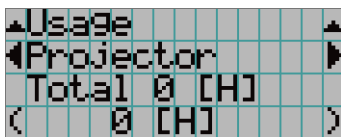

← Selects the item to display.

← Displays information about the selected item.

Projector	Displays the usage time of the projector. The upper row shows the usage time including standby mode while the lower row shows the usage time not including standby mode.
Light	Displays the usage time of the light.
Light Strike	Displays the number of times the light has been turned on.
Phosphor	Display of the usage time of the phosphor and the value that is displayed is the amount of usage time remaining (approximate).
Diffuser	Display of the usage time of the diffuser and the value that is displayed is the amount of usage time remaining (approximate).
Chiller	Display of the usage time of Chiller unit and the value that is displayed is the amount of usage time remaining (approximate).
Chiller Fan	Displays the usage time of the Chiller unit fan.
Filter Cleaning	Displays the usage time of the air filter.
Fan Usage	Displays the usage time of the fan.
Douser Count	Displays the number of times the douser has been used.

### 4-6-5. Error Code

Displays the error code when an error occurs.

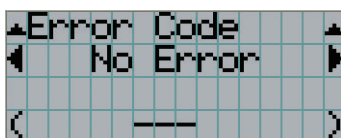

← Displays the code of the error currently occurring.

← Displays the name of the error currently occurring.

When multiple errors occur, you can display them by pressing the LEFT/RIGHT buttons.

## 4. Using Menus

### 4-6-6. Version

Displays version information about the projector, optional boards, and IMB.

#### System

Displays the version information of the projector.

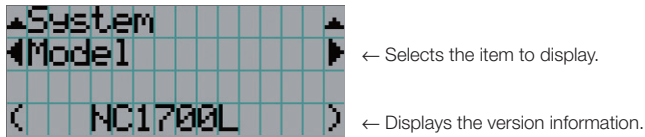

- Model
- Release Package
- U-Boot
- Cinema Firmware
- ICP Firmware
- FMT FPGA
- Slave Firmware
- Secure Processor
- Laser Driver
- Serial No.
- Kernel
- System Files
- Cinema Data
- ICP ConfigFile
- Slave BIOS
- Opt MCU
- Lens

#### IMB

Displays the vendor name and version information about the media block (IMB). When the projector is in standby mode, the vendor name is blank and the version information displays "---".

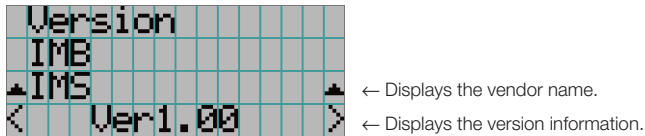

### 4-6-7. IP Address

Displays the IP address set in the projector.

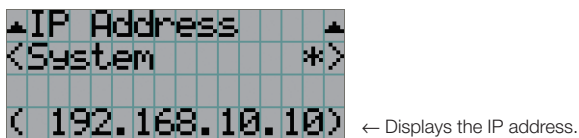

System	Displays the IP address set for the projector (System).
--------	---

### 4-6-8. Setup Date

Displays the date when the projector was set up (starting date of the warranty period).

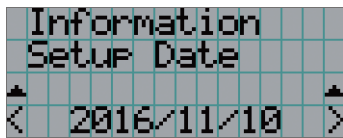

← Displays the date when the projector was set up (starting date of the warranty period).

### 4-6-9. Option Status

Displays the link status of the device mounted in slot on the projector. The device name is displayed in ( ) when the projector is in standby or when connection to the device cannot be confirmed.

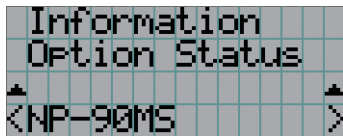

← Displays the link status of the device in slot.

- NP-90MS: NP-90MS02
- <Vendor Name> IMB: Media block
- No Board: No device mounted

---

---

# 5.

## Maintenance of Your Projector

---

---

**NOTE** Please request your dealer to perform cleaning of the projector inside.

### 5-1. Cleaning the Cabinet

Before carrying out maintenance of your projector and chiller unit, be sure to always check that the projector is turned off and the power plug is unplugged from the electrical outlet.

- Wipe with a dry, soft cloth without nap.

When the cabinet is excessively dirty, wipe with cloth well wrung after being dampened with a neutral detergent diluted with water and then finish up with a dry cloth.

When you use a chemical dust cloth, follow the instructions in the manual attached to it.

- Do not use a solvent, such as thinner or benzene. The coating may deteriorate or peel off.
- When removing dust on the ventilation opening, suck it off using an adapter with a brush on a vacuum cleaner. Never allow the cleaner without an adapter to come into direct contact or use a nozzle adapter in cleaning.
- Clean the ventilation opening at regular intervals. Dust, if allowed to accumulate there, may cause heating inside, which leads to functional trouble. The interval, which can vary with the location of your projector, is about 100 hours.
- Do not damage the cabinet by scratching it or allowing hard objects to hit it. This can scratch the projector.
- Consult your dealer/distributor about cleaning the inside of the projector.

**NOTE** Do not allow insecticide or other volatile liquid to splash on the cabinet, lens or screen. Also, do not allow any rubber or plastic object to remain in contact with the cabinet for a long time. The coating may deteriorate or peel off.

## 5-2. Cleaning the Lens

Clean the lens the same way as with camera lens (using a commercially available camera blower or cleaning paper for glasses). Take care not to damage the lens when cleaning.

# 6.

## Appendix

### 6-1. Troubleshooting

Before asking for repair, please check your connection, settings and operation once again. If the trouble cannot be corrected, please contact your dealer/distributor for instructions or repair.

#### 6-1-1. Problems and where to check

Problem	Check these items
The projector cannot be turned on.	Check to see if AC power is supplied to the projector and chiller unit.
	Make certain that the main power switch is ON.
	Check to see whether the panel key lock function is activated. If so, the main unit's control buttons are locked and do not work.
	Is the temperature inside the projector too high? When the inside temperature is too high, the protective function does not allow your projector to be turned on. Wait some time and then turn it on.
	Are you using the projector at high elevations with an altitude of approximately 5500 feet/1600 meters or higher? The cooling fan settings need to be configured when using the projector at high elevations. Please contact your dealer/distributor for instructions. Is the administrator key inserted? The projector will not function unless the administrator key is inserted.
The image cannot be projected.	Check to see if the connected input has been selected.
	Check to see if a cable is properly connected to the input terminal.
	Check to see whether the douser is closed.
	Check to see if the settings are all adjusted properly.
The image is distorted.	Check to see if the protractor is properly set up.
The image is blurred.	Make certain that the lens is properly focused.
	Check to see if the screen and a projector are installed at correct angles.
	The projection distance may be larger than the focusing range.
	See if the lens and other parts have condensation on them. If the projector is turned on in a warm place after storage in a cold place, the lens and other optical components inside may develop condensation. In such a case, please wait several minutes until the condensation disappears.

Problem	Check these items
Video image is disturbed.	Check whether the signal cable connected to the projector is disconnected.
The STATUS indicator blinks in red.	Your projector may have trouble. Please contact your dealer/distributor for instructions.
An error code is displayed.	Please contact your dealer/distributor for instructions.

## 6-2. Indicator display list

See the descriptions below when the buttons on the control panel or the STATUS indicator on the rear of the projector is lit or blinking. The projector also has a warning function that uses a buzzer.

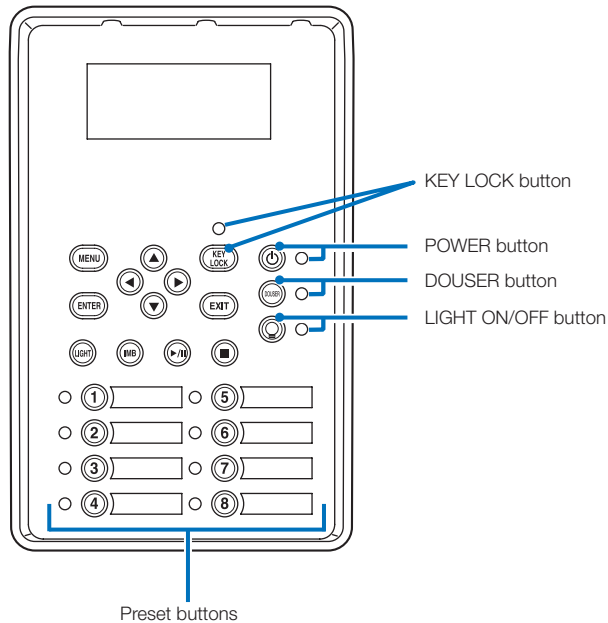

### 6-2-1. Preset buttons

Indicator condition	Projector condition	Note
Off	No title is assigned to the button.	-
Steady light	A title is assigned to the button.	-
	Green	The title is being selected.
White	The title is not selected.	-

### 6-2-2. KEY LOCK button

Indicator condition	Projector condition	Note
Off	The key lock is off.	-
Steady light	Orange	The key lock is on.

## 6. Appendix

### 6-2-3. POWER button

Indicator condition		Projector condition	Note
Off		The projector power supply is off.	-
Blinking light	Orange	While the projector software is starting	Wait for a moment.
	Green (cycles of 1) (Note 1)	Preparing to turn power on/cooling fan rotating (State from turning the power off to entering standby mode).	Wait for a moment.
	Green (cycles of 2) (Note 2)	State where power cannot be turned off (Immediately after turning the light on).	Wait for a moment. (for a maximum of about 90 seconds)
	Green (cycle of 3 seconds) (Note 3)	When the sleep timer is activated	-
Steady light	Green	The projector is turned on.	-
	Orange	The projector is in standby.	-

(Note 1) Repeats 0.5 seconds on → 0.5 seconds off.

(Note 2) Repeats 0.5 seconds on → 1.5 seconds off.

(Note 3) Repeats 2.5 seconds on → 0.5 seconds off.

### 6-2-4. DOUSER button

Indicator condition		Projector condition	Note
Steady light	Green	The douser is closed.	-
Off		The douser is opened.	-

### 6-2-5. LIGHT ON/OFF button

Indicator condition		Projector condition	Note
Off		The light is off.	-
Steady light	Green	The light is on.	-
Blinking light	Green (cycles of 2) (Note 1)	State where the light cannot be turned on/off (Immediately after turning the light on/off).	Wait for a moment. (for a maximum of about 90 seconds)

(Note 1) Repeat 0.5 seconds on → 1.5 seconds off.



## 6-2-6. STATUS indicator

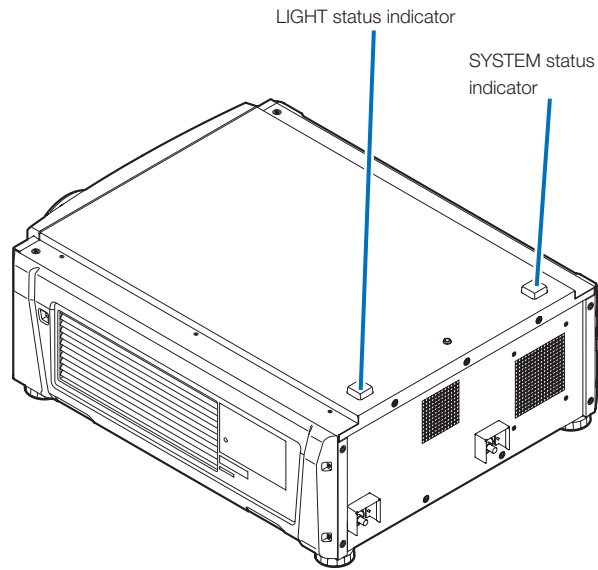

## SYSTEM status indicator

Indicator condition		Projector condition	Note
Off		Main power is off.	-
Blinking light	Green	The projector is getting ready to turn on. The douser is closed. The light is off.	Wait for a moment.
	Orange	The projector is cooling down.	Wait for a moment.
	Red (With buzzer)	Safety problem, error.	An error message is displayed in the LCD screen. Check the content of the error.
	Red (Without buzzer)	Error with possible image project under certain conditions.	
Steady light	Green	The projector is turned on.	-
	Orange	The projector is in standby.	-
	Red	Error at a level with not affect on projection.	An error message is displayed in the LCD screen. Check the content of the error.

## LIGHT status indicator

Indicator condition		Projector condition	Note
Off		The light source is off.	-
Steady light		The light source is on.	-

## 6-3. Operation using an HTTP browser

### 6-3-1. Overview

The use of HTTP server functions will allow control of the projector from a web browser. Please be sure to use “Microsoft Internet Explorer 4.x” or a higher version for the web browser.

This device uses “JavaScript” and “Cookies” and the browser should be set to accept these functions. The setting method will vary depending on the version of the browser. Please refer to the help files and the other information provided in your software.

**NOTE** The display's or button's response can be slowed down or operation may not be accepted depending on the settings of your network.  
Should this happen, consult your network administrator.  
The projector may not respond if its buttons are repeatedly pressed in rapid intervals. Should this happen, wait a moment and repeat.  
Access is gained to the HTTP server functions by and specifying  
`http://<the projector's IP address>/index.html`  
in the entry column of the URL.

### 6-3-2. Preparation before use

Make network connections and set up the projector and confirm that it is complete before engaging in browser operations.

Operations with a browser that uses a proxy server may not be possible depending on the type of proxy server and the setting method. Although the type of proxy server will be a factor, it is possible that items that have actually been set will not be displayed depending on the effectiveness of the cache, and the contents set from a browser not be reflected in operation. It is recommended that a proxy server not be used unless it is unavoidable.

### 6-3-3. Handling of the address for operation via a browser

Regarding the actual address that is entered for the address or entered to the URL column when operation of the projector is via a browser, the host name can be used as it is with the host name corresponding to the IP address of the projector has been registered in the domain name server by a network administrator, or the host name corresponding to the IP address of the projector has been set in the “HOSTS” file of the computer being used.

**(Example 1) When the host name of the projector has been set to “pj.nec.co.jp”**

`http://pj.nec.co.jp/index.html` is specified for the address or the entry column of the URL to access HTTP server functions.

**(Example 2) When the IP address of the projector is “192.168.10.10”**

`http://192.168.10.10/index.html` is specified for the address or the entry column of the URL to access HTTP server functions.

## 6-3-4. Structure of the HTTP server

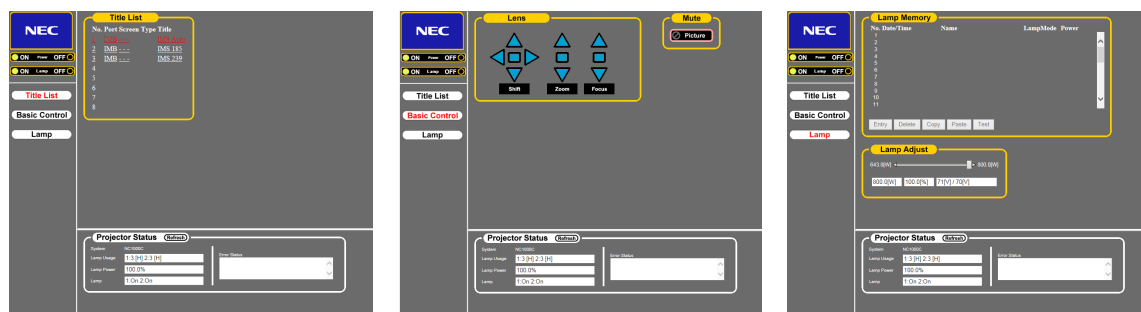

Power	Controls the power to your projector.	
	<ul style="list-style-type: none"> <li>• On: Turns the power on.</li> <li>• Off: Turns the power off.</li> </ul>	
Light	Turn the light on/off.	
	<ul style="list-style-type: none"> <li>• On: Turns the light on.</li> <li>• Off: Turns the light off.</li> </ul>	
Title List	Displays titles set in the projector (such as input port, screen type, and title). Check, and the title will be changed.	
Basic Control	Displays the basic control items.	
Lens	Controls the lens operation.	
	Shift	<ul style="list-style-type: none"> <li>▲ : Shifts the projected screen upward.</li> <li>▼ : Shifts the projected screen downward.</li> <li>◀ : Shifts the projected screen leftward.</li> <li>▶ : Shifts the projected screen rightward.</li> <li>■ : Stops the shifting.</li> </ul> Shifting can also be stopped by clicking the same button one more time.
	Zoom	<ul style="list-style-type: none"> <li>▲ : Zooms up the lens.</li> <li>▼ : Zooms down the lens.</li> <li>■ : Stops the zooming.</li> </ul> Zooming the can also be stopped by clicking the same button one more time.
	Focus	<ul style="list-style-type: none"> <li>▲ : Focuses up the lens.</li> <li>▼ : Focuses down the lens.</li> <li>■ : Stops the focusing.</li> </ul> Focusing can also be stopped by clicking the same button one more time.
Mute	Picture	Click and the douser closes and the projected picture disappears. Click once again and the picture will be projected again.
Projector Status	Displays the condition of the projector.	
	<ul style="list-style-type: none"> <li>• Light Usage: Displays the hours of light use.</li> <li>• Light Power: Displays light output (%).</li> <li>• Light Status: Displays the status of the light (On: Lights / Off: Off).</li> <li>• Error Status: Displays the status of errors occurring within the projector.</li> <li>• Refresh: Updates the display of the following conditions.</li> </ul>	
Light Memory	Entry	Saves the current light output value in the memory.
	Delete	Deletes the memory selected in the list from the Light Memory.
	Copy	Copies the memory selected in the list.
	Paste	Saves/overwrites the copied memory to the selected memory in the list.
	Test	Tests the adjustment value of the memory selected in the list.

## 6-4. Writing of the log file (Save Information)

Log files saved on the main unit can be written to USB memory connected to the USB port of the main unit. To perform the writing of the log file, use the following procedure.

**1** Connect the USB memory to the USB port of the main unit.

Wait until the USB memory is recognized, and it enters the condition in which it can be used (5 or more seconds). For details, refer to the instruction guide of the USB memory.

**2** Simultaneously press the UP button and ENTER button.

The "Save Info." screen is displayed.

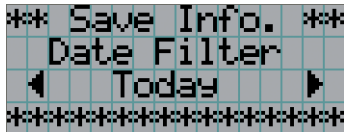

**TIP** If you press the EXIT button during operation, operation is stopped and the display returns to the normal screen.

**3** Press the LEFT/RIGHT button, and select the log file writing period.

The items that can be selected are as follows.

Today	Writes today's log files.
7days	Writes 7 days' log files from today.
30days	Writes 30 days' log files from today.
2years	Writes 2 years' log files from today.
Manual	Writes the specified period's log files.

**4** Press the ENTER button.

When "Today", "7days", "30days" or "2years" is selected, the log file writing period is displayed.

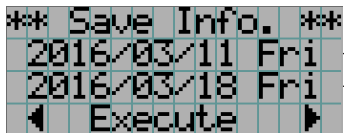

← The log file writing period is displayed.

When "Manual" is selected, specify the log file writing period. For how to enter numerals, refer to "4-1-3. How to enter alphanumeric characters" (See page 51). If you press the ENTER button, the display advances to the following screen.

```

** Save Info. **
Date Filter
From Date
[2016/03/18 Fri]

```

← Enter the date/time to start writing.

Press the ENTER button.

```

** Save Info. **
Date Filter
To Date
[2016/12/21 Wed]

```

← Enter the date/time to stop writing.

Press the ENTER button.

```

** Save Info. **
2016/03/18 Fri
2016/12/21 Wed
◀ Execute ▶

```

← The log file writing period is displayed.

- 5** Confirm the log file writing period, press the LEFT/RIGHT button to select "Execute," and press the ENTER button.

The log files of the specified period are written to the USB device. When writing completes, the following screen is displayed.

```

** Save Info. **
Complete(USB)
<OK>
*****

```

**TIP** If you select "Cancel" and press the ENTER button, the writing of log files is stopped, and the display returns to the normal screen.

- 6** Press the ENTER button.

The display returns to the normal screen.

```

Light 100H
      80%
Title
292-A

```

- 7** Remove the USB from the USB port of the main unit.

### 6-4-1. Names of log files

Written log files are saved with the following file names.

(Model name)\_(Serial Number)\_YYMMDDHHmm.txt

(Model name)	This shows the model of projector.
(Serial Number)	This shows the serial number of projector.
YYMMDDHHmm	Shows the date/time when written. YY: Year (lower 2 digits) MM: Month (2 digits) DD: Date (2 digits) HH: Hour (2 digits) mm: Minute (2 digits)

For example, if NC1700L log file is written at 14:05 on November 10, 2016, it is saved with the "NC1700L\_abcd1234\_1611101405.txt" file name.

## 6-5. Outline Drawing

### 6-5-1. Projector

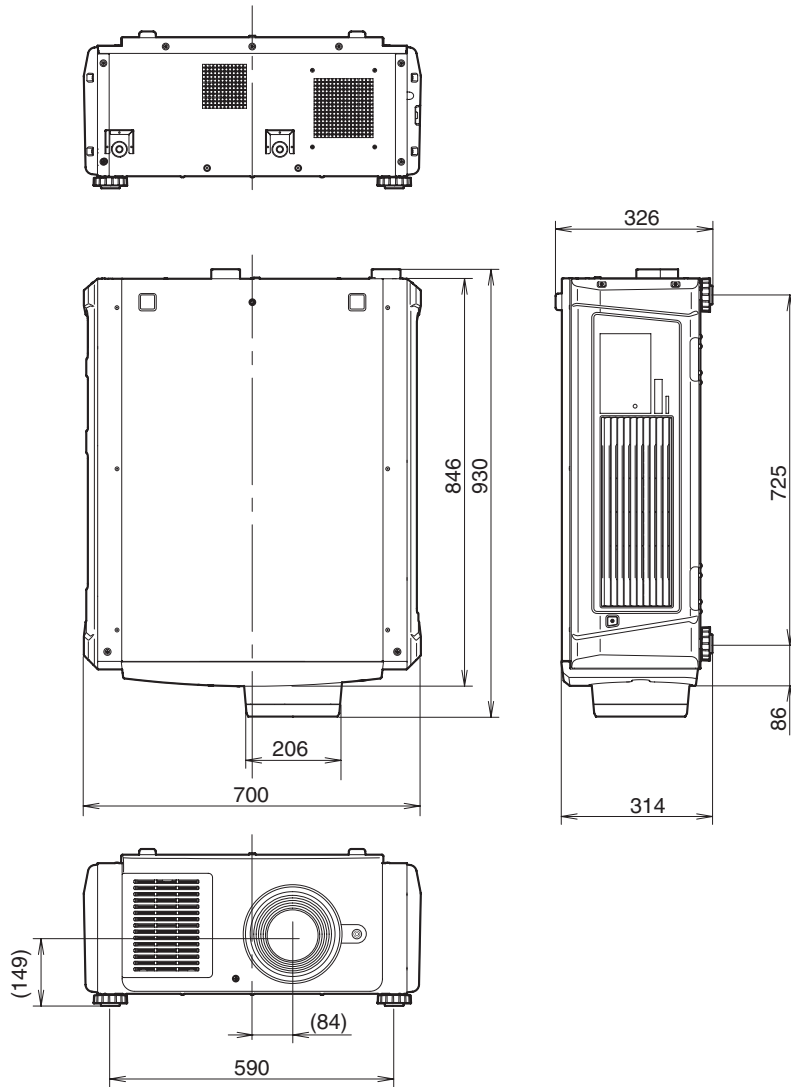

Units: mm

6-5-2. Chiller unit (NP-17CU01)

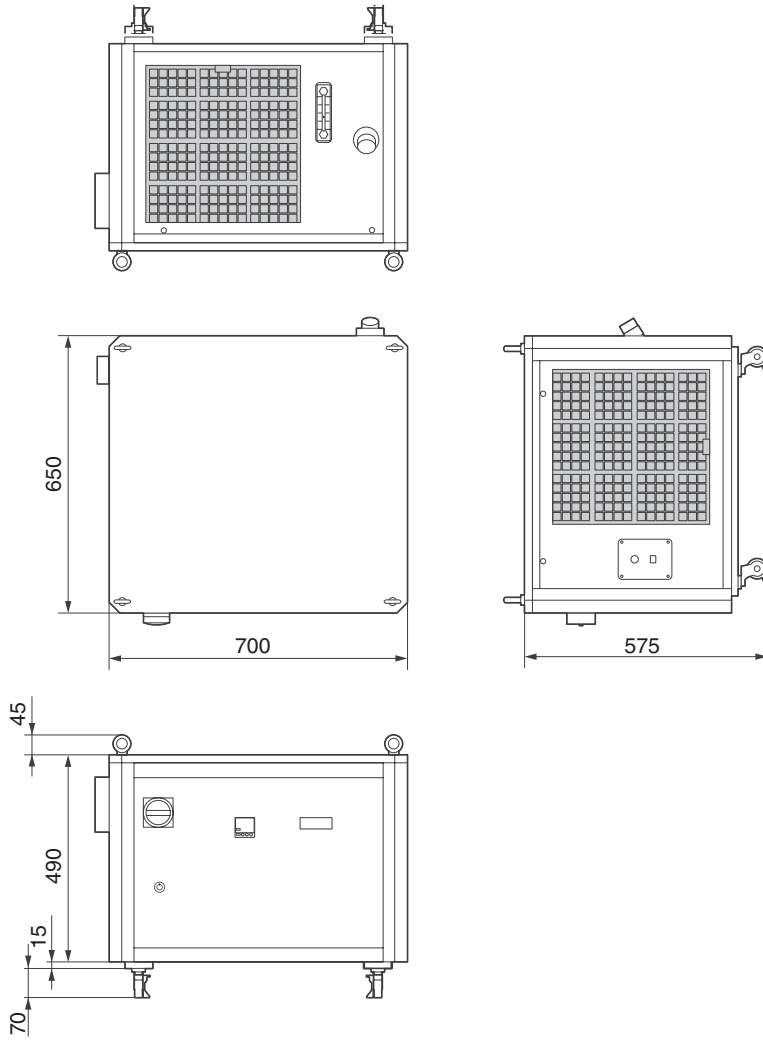

Units: mm



## 6-6. Specifications

### 6-6-1. Projector

Model name	NC1700L		
Projection method	3 chip DLP Cinema® method		
	0.69-inch DC2K chip		
Panel resolution	2048 x 1080		
Light type	Red, blue : Laser diode Green : Blue laser diode + Phosphor		
Screen sizes	Max. 17 m @14ft-L / Screen Gain 1.8 (Depends on setup conditions)		
Contrast ratio	1600:1 with DCI specified color representation		
Lens adjustment function	Motorized lens shift (vertical/horizontal), motorized zoom, motorized focus, douser		
Signal input ports	When shipped from factory: Empty (for mounting optional components) (Note 1)		
External Control	RS-232C (D-sub 9pin) x 1 GPIO port (D-sub 37 pin) x 1 Service terminal (stereo mini jack) x 1 3D CTL (D-sub 15 pin) x 1 USB (Type A) x 1 Interlock port x 1 Ethernet port (G-bit RJ-45) x 1 Chiller unit control port x 1		
Power supply voltage	AC 200 to 240 V, 50/60 Hz single phase		
Input current	10.7A (MAX) (200V)		
Power consumption	2140W (MAX) (200V) (Note 2)		
Cooling method	Cooling air system and cooling liquid system using a chiller unit		
Noise level	Less than 55 dB		
Installation	Orientation: Desktop/front, Desktop/rear		
Net weight	68.5 kg (Excluding lens)		
Dimensions	700 mm (W) x 930 mm (D) x 326 mm (H) (Does not include protruding portions, includes foot.)		
Environment	Operating temperature: 10 to 35°C Operating humidity: 10 to 85% (non-condensing) Storage temperature: -10 to 50°C Storage humidity: 10 to 85% (non-condensing) Operating altitude: 0 to 3000 m/9800 feet (1600 m/5500 feet to 3000 m/9800 feet: Set "Fan Speed Mode" to "High Altitude")		
Regulations		<Safety>	<EMC>
	USA	UL60950-1	FCC Part15 Class A
	Canada	CSA60950-1	ICES-003 Class A
	Europe	EN60950-1	EN55032 Class A, EN55024, EN61000-3-2/-3-3
	Russia Belarus Kazakhstan	IEC60950-1	EN55022 Class A, EN55024, EN61000-3-2/-3-3
	Oceania	IEC60950-1	AS/NZS CISPR. 32 Class A
	Asia	IEC60950-1	CISPR. 32 Class A
	Korea	K60950-1	KN32 Class A, KN35
	Saudi Arabia	IEC60950-1	EN55022 Class A, EN55024, EN61000-3-2/-3-3
	Japan	J60950-1, J3000	VCCI Class A, JIS C 61000-3-2, J55022 Class-A
India	IS13252	-	

(Note 1) The video input slots are empty when the device is shipped. Input ports can be added by mounting option boards, which are sold separately. (See page 84)

(Note 2) The value is typical.

\* Note that these specifications and design can change without prior notice.

## 6. Appendix

### 6-6-2. Chiller unit

Model name	NP-17CU01
Power supply voltage	AC 200 to 240 V 50 Hz, AC 220 to 240 V 60 Hz single phase
Input current	9.2 A (50 Hz) / 10.3 A (60 Hz)
Power consumption	1610 W (50 Hz) / 2000 W (60 Hz)
Net weight	108 kg (Does not include coolant weight)
Dimensions	700 mm (W) x 650 mm (D) x 575 mm (H) (Does not include protruding portions, includes foot.)
Environment	Operating temperature: 10 to 35°C Operating humidity: 10 to 85% (non-condensing) Storage temperature: -10 to 50°C Storage humidity: 10 to 85% (non-condensing) Operating altitude: 0 to 3000 m/9800 feet

\* Note that these specifications and designs can change without prior notice.



#### **CAUTION**

1. This appliance shall not be accessible to the general public.
2. This appliance can be used by children aged from 8 years and above and persons with reduced physical, sensory or mental capabilities or lack of experience and knowledge if they have been given supervision or instruction concerning use of the appliance in a safe way and understand the hazards involved.
3. Children shall not play with the appliance. Cleaning and user maintenance shall not be made by children without supervision.
4. This appliance shall be installed in accordance with national wiring regulations.
5. An all-pole disconnection switch having a contact separation of at least 3mm in all poles should be connected in fixed wiring.
6. If the supply cord is damaged, it must be replaced by the manufacturer, its service agent or a similarly qualified person in order to avoid a hazard.
7. This appliance is not intended for use by persons (including children) with reduced physical, sensory or mental capabilities, or lack of experience and knowledge, unless they have been given supervision or instruction concerning use of the appliance by a person responsible for their safety.
8. Children should be supervised to ensure that they do not play with the appliance.
9. Cleaning and user maintenance shall not be made by children without supervision.
10. Disconnect the appliance from its power source during service and when replacing parts.
11. Disconnect the power supply before cleaning and maintenance.
12. This appliance is for indoor use only.
13. This appliance is intended to be used by expert or trained users.

## 6-7. Power Cable

**NOTE** Ask your dealer for the power cable to select and purchase.

### Power Cable Electrical Specification

The projector is equipped with an IEC60320 C19 connector to connect an AC power supply cable. Ensure that the AC power cables that connect the connectors built into the projector to the AC power maintains the current capacities as shown below.

Power supply voltage	Projector input current	Power cable current capacity
AC 200–240V	10.7A (MAX)	250V 16A or higher

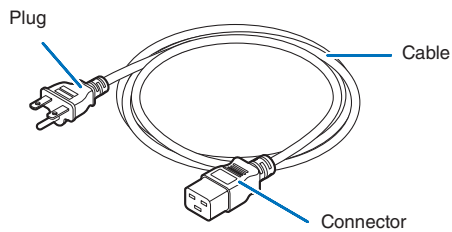

### Type of Power Cable



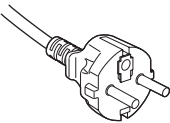

Use plugs, cables, and connectors that are suitable for the regulations of the country of installation, as shown in the following table.

**NOTE** For users in North America  
Use a power cable no longer than 4.5m/14.76 ft according to National Electrical Code.

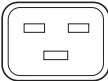
### Germany

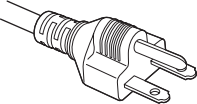

Plug	Cable	Connector
CEE 7 	H05VV-F 3G1.5 	IEC 320 C19 

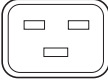
### USA

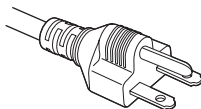

Plug	Cable	Connector
NEMA 6-15P 	SJT 3 x AWG 14 	IEC 320 C19 

## 6. Appendix

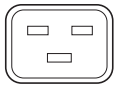
### Japan

Plug	Cable	Connector
JIS C 8303 	VCTF 3 x 2.0mm 	IEC 320 C19 

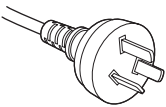
### China

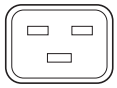
Plug	Cable	Connector
GB2099 	RWV 300/500 	GB17465.1 

### Connector

Dimensions of the connector of the power cable are shown below.

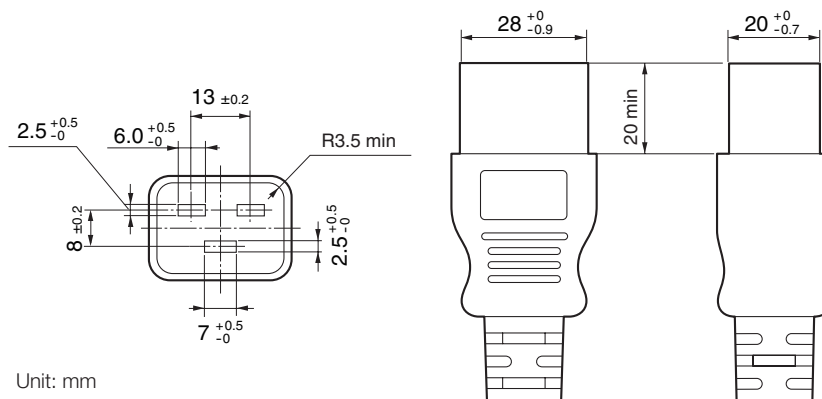

## 6-8. Pin Assignment and Functions of Terminal

### 6-8-1. PC CONTROL connector (RS-232) (D-sub 9 pin)

This is an RS-232C interface for controlling the projector from a PC. The projector operates as a DCE (Data Communication Equipment), so use a straight cable when connecting to a PC.

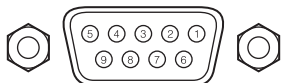

Pin No.	RS-232C Signal Name	Functions as RS-232C	Projector Connector Operation
1	CD	Carrier detection	Not used (N.C.)
2	RXD	Reception data	Data transmission to an external device
3	TXD	Transmission data	Data reception from an external device
4	DTR	Data Terminal ready (Note)	Connection to 6 pins
5	GND	Signal GND	Signal GND
6	DSR	Data set ready (Note)	Connection to 4 pins
7	RTS	Transmission request	SYSTEM: Hi-Z (Not used) CINEMA: Hi-Z (Used)
8	CTS	Transmission available	SYSTEM: Fixed at -6.5 V (Not used) CINEMA: $\pm 10.5$ V (Used: Depends on communication status)
9	RI	Ring indicator	Not used (N.C.)

(Note) Do not use DTR and DSR signals when communicating.

## 6. Appendix

### 6-8-2. External control connector (GP I/O) (D-sub 37 pin)

It is possible to control the projector with an external device and to control the external device from the projector using an external control connector (GPIO: General Purpose I/O Ports). Each pin is electrically separated from the projector internal circuits by a photo-coupler. 8 port input and 8 port output are available.

Please contact your dealer/distributor regarding how to use and to operate them.

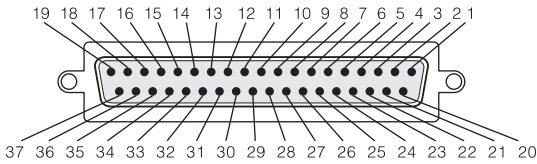

Pin view of female connector

Pin No.	Signal Name	I/O	Pin No.	Signal Name	I/O
1	GPIN1+ (3D L/R Input Reference +)	IN	20	GPIN1- (3D L/R Input Reference -)	IN
2	GPIN2+ (3D L/R Display Reference +)	IN	21	GPIN2- (3D L/R Display Reference -)	IN
3	GPIN3+ (system reserved)	IN	22	GPIN3- (system reserved)	IN
4	GPIN4+ (system reserved)	IN	23	GPIN4- (system reserved)	IN
5	EXT_GPIN1+ (Control and Title Selection +)	IN	24	EXT_GPIN1- (Control and Title Selection -)	IN
6	EXT_GPIN2+ (Control and Title Selection +)	IN	25	EXT_GPIN2- (Control and Title Selection -)	IN
7	EXT_GPIN3+ (Control and Title Selection +)	IN	26	EXT_GPIN3- (Control and Title Selection -)	IN
8	EXT_GPIN4+ (Control and Title Selection +)	IN	27	EXT_GPIN4- (Control and Title Selection -)	IN
9	GPOUT1+ (External 3D L/R Output Reference +)	OUT	28	GPOUT1- (External 3D L/R Output Reference -)	OUT
10	GPOUT2+ (system reserved)	OUT	29	GPOUT2- (system reserved)	OUT
11	GPOUT3+ (system reserved)	OUT	30	GPOUT3- (system reserved)	OUT
12	GPOUT4+ (Internal 3D L/R Output Reference +)	OUT	31	GPOUT4- (Internal 3D L/R Output Reference -)	OUT
13	EXT_GPOUT1+ (Projector Ready/Busy +)	OUT	32	EXT_GPOUT1- (Projector Ready/Busy -)	OUT
14	EXT_GPOUT2+ (Projector Error Status +)	OUT	33	EXT_GPOUT2- (Projector Error Status -)	OUT
15	EXT_GPOUT3+ (IMB Play/End Status +)	OUT	34	EXT_GPOUT3- (IMB Play/End Status -)	OUT
16	EXT_GPOUT4+ (Projector Heartbeat +)	OUT	35	EXT_GPOUT4- (Projector Heartbeat -)	OUT
17	NC (not connected)	-	36	NC (not connected)	-
18	GND	PWR	37	GND	PWR
19	GND	PWR	-	-	-

EXT\_GPIN1 - EXT\_GPIN4: You can control the projector externally by combinations of input signals (high/low). (Projector power supply/turning the light source on or off/image mute/title selection)

EXT\_GPOUT1 - EXT\_GPOUT4: Functions in the above table are default settings. You can change the assigned functions.

## Input Connector

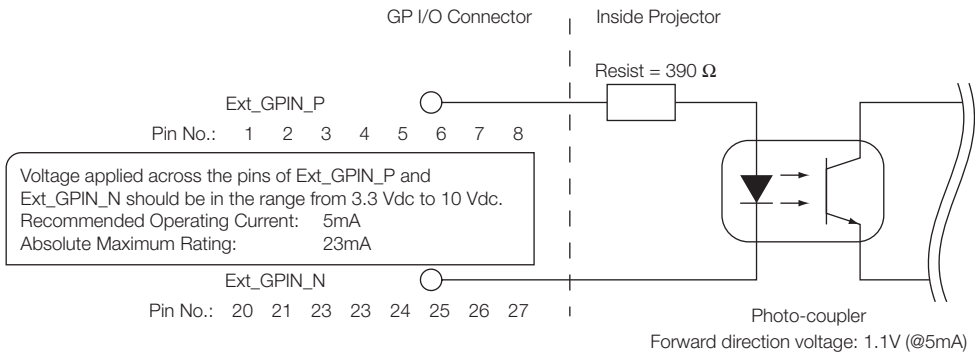

### • Using GPIO Control

Momentary “ON” pulse enables you to control projector. To enable “ON” pulse, hold it for at least 500 ms. Hold “OFF” for at least 500 ms before “ON”. (See page 80)

Here is function list to control projector by using GPIO port.

Pin No.	Photo-coupler ON/OFF				Function
1-20	ON/OFF				3D L/R timing signal input ON/OFF
2-21	ON/OFF				3D L/R display timing signal input ON/OFF
3-22	-				System reserved (used internally)
4-23	-				System reserved (used internally)
5-24 6-25 7-26 8-27	8-27	7-26	6-25	5-24	The following functions apply depending on the combination of input terminals.
	OFF	OFF	OFF	ON	Power ON
	OFF	OFF	ON	OFF	Power OFF
	OFF	OFF	ON	ON	Light source ON
	OFF	ON	OFF	OFF	Light source OFF
	OFF	ON	OFF	ON	Image douser ON
	OFF	ON	ON	OFF	Image douser OFF
	OFF	ON	ON	ON	System reserved (used internally)
	ON	OFF	OFF	OFF	Selects the title registered to the preset button 1
	ON	OFF	OFF	ON	Selects the title registered to the preset button 2
	ON	OFF	ON	OFF	Selects the title registered to the preset button 3
	ON	OFF	ON	ON	Selects the title registered to the preset button 4
	ON	ON	OFF	OFF	Selects the title registered to the preset button 5
	ON	ON	OFF	ON	Selects the title registered to the preset button 6
	ON	ON	ON	OFF	Selects the title registered to the preset button 7
	ON	ON	ON	ON	Selects the title registered to the preset button 8

Example for dousing image: Input ON to 5-24 and 7-26 while 6-25 and 8-27 are OFF.

Example for selecting the preset button 2: Input ON to 5-24 and 8-27 while 6-25 and 7-26 are OFF.

#### NOTE

- The operation command coming from GPI/O port will be canceled when the projector is processing other tasks, such as light source cooling and switching title.
- Set all other pins than those in use to “OFF”.
- The operation command is executed upon continuous input of the “ON” pulse for approximately 200 ms.

## 6. Appendix

### • Timing chart of GPIO control

Example of Select Preset Button

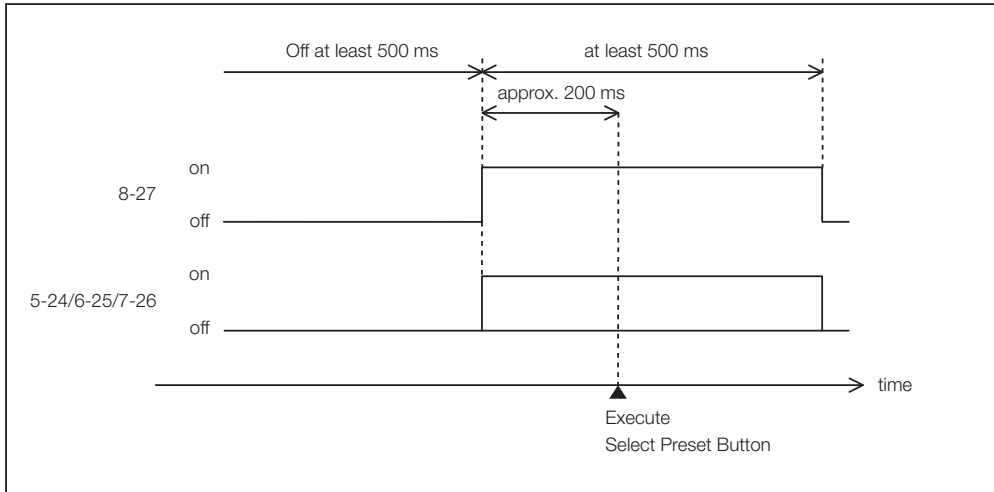

Example for turning the image douser (Douser) on

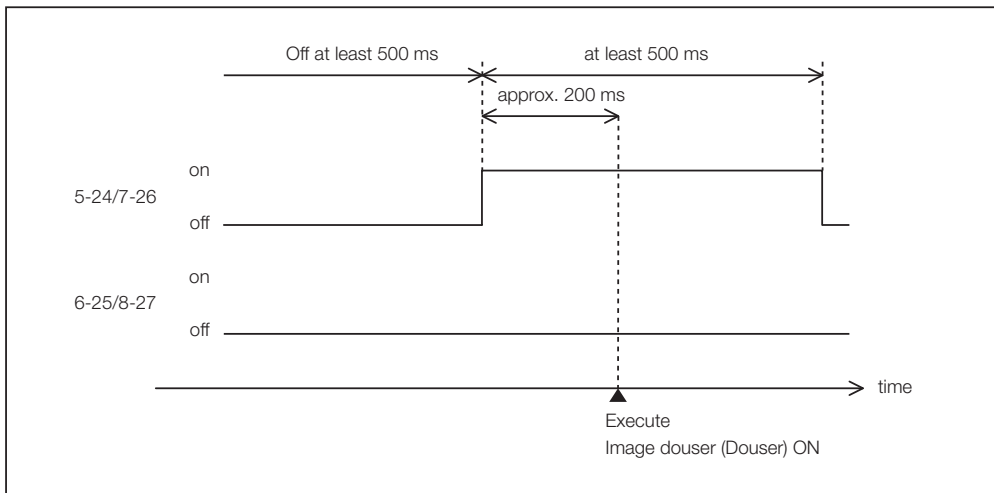



Example of Light source On

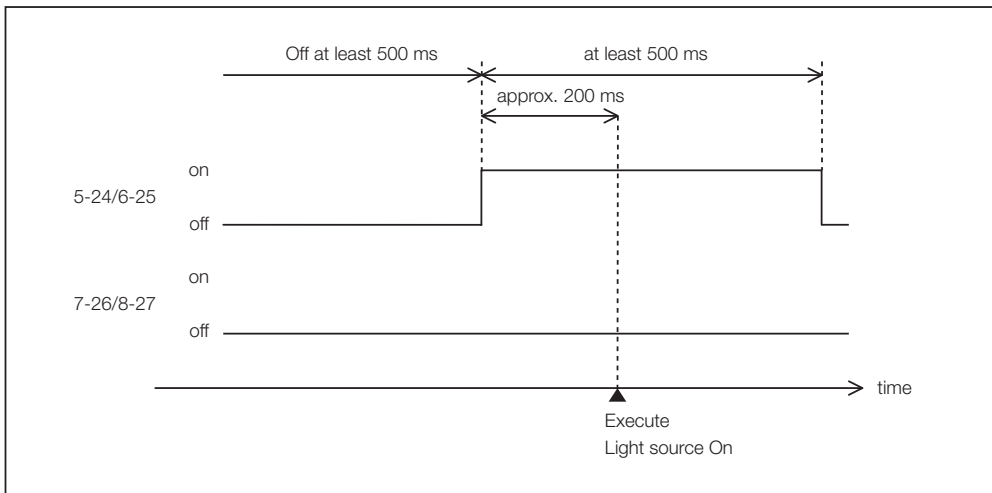

Example for turning the power off

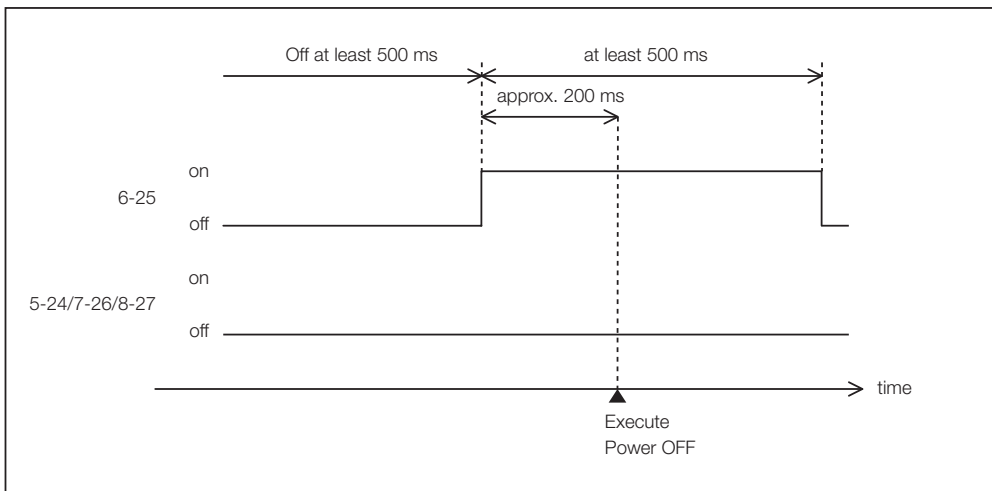

**Output Connector**

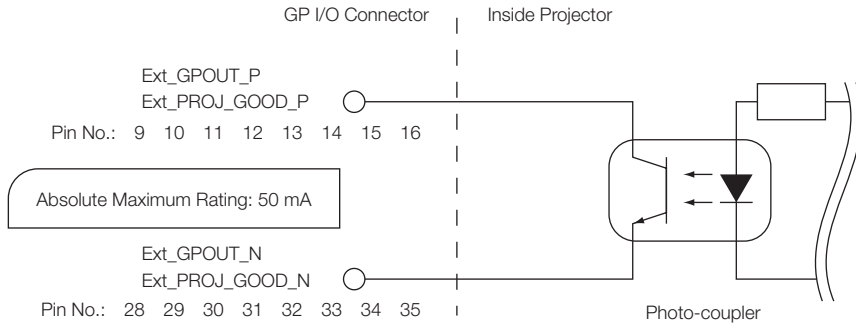

• **Using GPIO Control**

You can use GPIO control for the projector's health check and error check. Also, you can use the output as the trigger to control external devices.

The following functions are assigned to the pin number 13-32, 14-33, 15-34, and 16-35 (EXT\_GPOUT1 - EXT\_GPOUT4) as the default. You can change the assigned functions.

Pin No.	Photo-coupler ON/OFF	Function
9-28	ON/OFF	External 3D L/R timing signal output ON/OFF
10-29	-	System reserved (used internally)
11-30	-	System reserved (used internally)
12-31	ON/OFF	Internal 3D L/R timing signal output ON/OFF
13-32	ON/OFF	GPIO control status check ON: GPIO control (input) is unavailable. OFF: GPIO control (input) is available.
14-33	ON/OFF	Error check ON: Error OFF: No error
15-34	ON/OFF	IMB status check ON: The content is being played. OFF: The content is stopped/paused.
16-35	ON/OFF	Health check (heart beat) ON and OFF are alternately output when operations are normal.

### 6-8-3. 3D connector (D-sub 15 pin)

This is used to connect a 3D image system to the projector.

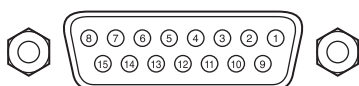

Pin view of a female connector

Pin No.	Signal Name	I/O	Function
1	+12V	PWR	Supplies power (+12V) to the 3D image system
2	GNDC	GND	Ground
3	GNDC	GND	Ground
4	RS232_RX	IN	Data transmission from the 3D image system (1200 Baud, 8 bits, No Parity)
5	RS232_TX	OUT	Data transmission to the 3D image system (1200 Baud, 8 bits, No Parity)
6	CONN_3D_MODE+	OUT	3D mode status (+) (Connects to the collector of the output transistor of the photo coupler inside the projector)
7	CONN_SYNC+	OUT	3D L/R switching timing signal (+) (Connects to the collector of the output transistor of the photo coupler inside the projector)
8	3D_INPUT_REFERENCE+	IN	3D L/R timing signal (+) (Connects to the anode of the input diode of the photo coupler inside the projector)
9	+12V	PWR	Supplies power (+12V) to the 3D image system
10	3D_INPUT_REFERENCE-	IN	3D L/R timing signal (-) (Connects to the cathode of the input diode of the photo coupler inside the projector)
11	3D_DISPLAY_REFERENCE+	IN	3D L/R display timing signal (+) (Connects to the anode of the input diode of the photo coupler inside the projector)
12	3D_DISPLAY_REFERENCE-	IN	3D L/R display timing signal (-) (Connects to the cathode of the input diode of the photo coupler inside the projector)
13	CONN_3D_MODE-	OUT	3D mode status (-) (Connects to the emitter of the output transistor of the photo coupler inside the projector)
14	CONN_SYNC-	OUT	3D L/R switching timing signal (-) (Connects to the emitter of the output transistor of the photo coupler inside the projector)
15	N/C	-	Unused

## 6-9. Related products list

Product name		Lens memory support	Model name
Lens	Zoom lens 1.63 to 2.03	–	NP-9LS16Z1
	Zoom lens 2.03 to 2.72	–	NP-9LS20Z1
	Zoom lens 4.07 to 6.34	–	NP-9LS40Z
	Zoom lens 1.2 to 1.72	○	NP-9LS12ZM1
	Zoom lens 1.33 to 2.1	○	NP-9LS13ZM1
	Zoom lens 1.62 to 2.7	○	NP-9LS16ZM1
	Zoom lens 2.09 to 3.9	○	NP-9LS20ZM1
	Zoom lens 4.07 to 6.34	○	NP-9LS40ZM1
Integrated Media Server	Integrated Media Server		NP-90MS02

